

# WILDEN®

# EOM

Engineering  
Operation &  
Maintenance

PS4  
Saniflo™ Hygienic Series  
Metal Pumps

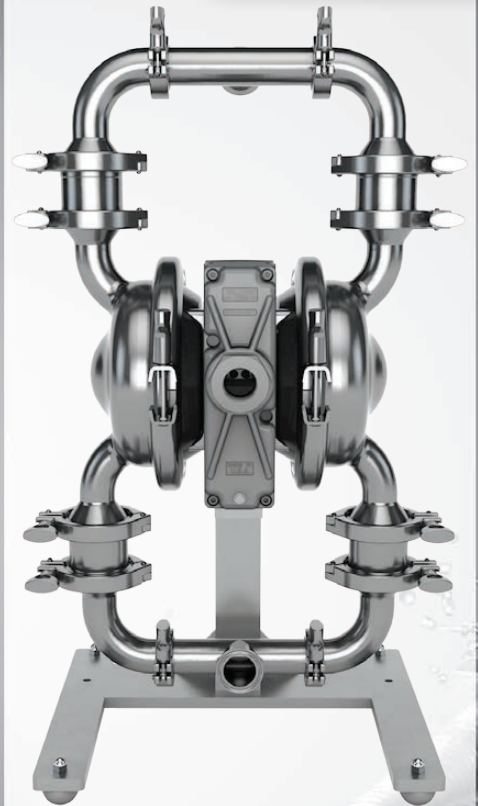

Where Innovation Flows

[wildenpump.com](http://wildenpump.com)

  
a **DOVER** company

**TABLE OF CONTENTS**

**SECTION 1 CAUTIONS—READ FIRST! ..... 1**

**SECTION 2 WILDEN PUMP DESIGNATION SYSTEM ..... 2**

**SECTION 3 HOW IT WORKS—PUMP & AIR DISTRIBUTION SYSTEM ..... 3**

**SECTION 4 DIMENSIONAL DRAWINGS ..... 4**

**SECTION 5 PERFORMANCE**

    PS4 Saniflo™ HS Rubber-Fitted ..... 5

    PS4 Saniflo™ HS EZ-Install TPE-Fitted ..... 5

    PS4 Saniflo™ HS Full-Stroke PTFE Fitted ..... 6

    PS4 Saniflo™ HS Full-Stroke Integral Piston Diaphragm-Fitted ..... 6

    PS4 Saniflo™ HS PTFE Integral Piston Diaphragm-Fitted ..... 7

    Suction-Lift Curves ..... 8

**SECTION 6 SUGGESTED INSTALLATION, OPERATION & TROUBLESHOOTING ..... 9**

**SECTION 7 DISASSEMBLY / REASSEMBLY ..... 12**

    Wilgard™ Diaphragm Sensor ..... 15

    Air Valve / Center Section Disassembly ..... 17

    Reassembly Hints & Tips ..... 21

**SECTION 8 CLEAN-IN-PLACE - CIP ..... 22**

**SECTION 9 EXPLODED VIEW & PARTS LISTING**

    PS4 Saniflo™ HS ..... 24

    PS4 Saniflo™ HS 1935/2004/EC ..... 28

**SECTION 10 ELASTOMER OPTIONS ..... 31**





## CAUTIONS—READ FIRST!

 **CAUTION:** Do not apply compressed air to the exhaust port — pump will not function.

 **CAUTION:** Do not over-lubricate air supply — excess lubrication will reduce pump performance. Pump is pre-lubed.

 **TEMPERATURE LIMITS:**

Acetal	–29°C to 82°C	–20°F to 180°F
Buna-N	–12°C to 82°C	10°F to 180°F
Geolast®	–40°C to 82°C	–40°F to 180°F
Neoprene	–18°C to 93°C	0°F to 200°F
Nordel® EPDM	–51°C to 138°C	–60°F to 280°F
Nylon	–18°C to 93°C	0°F to 200°F
PFA	–7°C to 107°C	45°F to 225°F
Polypropylene	0°C to 79°C	32°F to 175°F
Polyurethane	–12°C to 66°C	10°F to 150°F
PVDF	–12°C to 107°C	10°F to 225°F
Saniflex™	–29°C to 104°C	–20°F to 220°F
SIPD PTFE with EPDM-backed	4°C to 137°C	40°F to 280°F
SIPD PTFE with Neoprene-backed	4°C to 93°C	40°F to 200°F
PTFE <sup>1</sup>	4°C to 104°C	40°F to 220°F
Viton® FKM	–40°C to 177°C	–40°F to 350°F
Wil-Flex™	–40°C to 107°C	–40°F to 225°F

<sup>1</sup>4°C to 149°C (40°F to 300°F) - 13 mm (1/2") and 25 mm (1") models only.

**NOTE:** Not all materials are available for all models. Refer to Section 2 for material options for your pump.

 **CAUTION:** When choosing pump materials, be sure to check the temperature limits for all wetted components. Example: Viton® has a maximum limit of 177°C (350°F), but polypropylene has a maximum limit of only 79°C (175°F).

 **CAUTION:** Maximum temperature limits are based upon mechanical stress only. Certain chemicals will significantly reduce maximum safe operating temperatures. Consult the Chemical Resistance Guide for chemical compatibility and temperature limits.

 **WARNING:** Prevent static sparking. If static sparking occurs, fire or explosion could result. Pump, valves and containers must be grounded to a proper grounding point when handling flammable fluids and whenever discharge of static electricity is a hazard.

 **CAUTION:** Do not exceed 8.6 bar (125 psig) air supply pressure.

 **CAUTION:** The process fluid and cleaning fluids must be chemically compatible with all wetted pump components. Consult the Chemical Resistance Guide.

 **CAUTION:** Do not exceed 82°C (180°F) air inlet temperature for Pro-Flo® SHIFT models.

 **CAUTION:** Pumps should be thoroughly flushed before installing into process lines. FDA- and USDA-approved pumps should be cleaned and/or sanitized before being used.

 **CAUTION:** Always wear safety glasses when operating pump. If diaphragm rupture occurs, material being pumped may be forced out air exhaust.

 **CAUTION:** Before any maintenance or repair is attempted, the compressed air line to the pump should be disconnected and all air pressure allowed to bleed from pump. Disconnect all intake, discharge and air lines. Drain the pump by turning it upside down and allowing any fluid to flow into a suitable container.

 **CAUTION:** Blow out air line for 10 to 20 seconds before attaching to pump to make sure all pipeline debris is clear. Use an in-line air filter. A 5µ (micron) air filter is recommended.

 **NOTE:** When installing PTFE diaphragms, it is important to tighten outer pistons simultaneously (turning in opposite directions) to ensure tight fit. When installing IPDs and FSIPDs, these diaphragms cannot be over-tightened by hand; do not use tools when tightening. (See torque specifications in Section 7.)

 **NOTE:** Some PTFE-fitted pumps come standard from the factory with expanded PTFE gaskets installed in the diaphragm bead of the liquid chamber. PTFE gaskets cannot be re-used.

 **NOTE:** Before starting disassembly, mark a line from each liquid chamber to its corresponding air chamber. This line will assist in proper alignment during reassembly.

 **CAUTION:** Pro-Flo® SHIFT pumps are available in both submersible and non-submersible options. Do not use standard models in submersible applications.

 **CAUTION:** Tighten all hardware prior to installation.



**WILDEN PUMP DESIGNATION SYSTEM**

**PS4 SANIFLO™  
HYGIENIC SERIES**

**38 mm (1-1/2") Pump  
Maximum Flow Rate:  
357 lpm (94.4 gpm)**

**LEGEND**

**PS4 / XXXXX / XXX / XX / XX / XXXX**

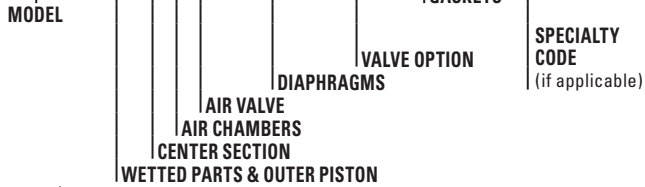

**MATERIAL CODES**

**MODEL**

XPS4 = 38 mm (1-1/2") ATEX

**WETTED PARTS/  
OUTER PISTON**

SS = 316L STAINLESS STEEL  
SZ = 316L STAINLESS STEEL/  
NO PISTON

**CENTER BLOCK**

N = NICKEL-PLATED ALUMINUM  
S = 316 STAINLESS STEEL

**AIR CHAMBERS**

N = NICKEL-PLATED ALUMINUM  
S = 316 STAINLESS STEEL

**AIR VALVE**

N = NICKEL-PLATED ALUMINUM  
S = 316 STAINLESS STEEL

**DIAPHRAGMS**

FBS = SANITARY BUNA<sup>1,5</sup>  
(Two Yellow Dots)  
FES = SANITARY EPDM<sup>1,5</sup>  
(Two Blue Dots)  
FSS = SANIFLEX™<sup>1,5</sup>  
FWL = FULL-STROKE SANITARY  
WIL-FLEX™ IPD<sup>1,3,4,5</sup>  
FWS = SANITARY WIL-FLEX™,  
EZ-INSTALL [Santoprene®  
(Two Orange Dots)]<sup>1,5</sup>  
LEL = PTFE IPD<sup>1,2,3,4,5</sup>  
TSS = FULL-STROKE PTFE  
w/SANIFLEX™ BACK-UP<sup>1,2,5</sup>  
TWS = FULL-STROKE PTFE  
w/WIL-FLEX™ BACK-UP<sup>1,2,5</sup>  
ZSS = SANIFLEX™, EZ-INSTALL<sup>1,3</sup>

**BALL VALVES, MUSHROOM  
CHECK VALVES**

FB = SANITARY BUNA<sup>1,3,4,5</sup>  
(Red Dot)  
FE = SANITARY EPDM<sup>1,3,4,5</sup>  
(Green Dot)  
FS = SANIFLEX™<sup>1,3,4,5</sup>  
FW = SANITARY WIL-FLEX™  
[Santoprene® (Two Orange  
Dots)]<sup>1,3,4,5</sup>  
TF = PTFE<sup>1,2,3,4,5</sup>  
TM = PTFE MUSHROOM  
CHECK<sup>1,2,5</sup>

**MANIFOLD GASKETS**

FB = SANITARY BUNA-N<sup>1,3,4,5</sup>  
(Red Dot)  
FE = SANITARY EPDM<sup>1,3,4,5</sup>  
(Green Dot)  
FV = SANITARY VITON®<sup>1,3,4,5</sup>  
(One White/One Yellow Dot)  
TF = PTFE<sup>1,2,3,4,5</sup>

**NOTE:**

- <sup>1</sup>Meets Requirements of FDA CFR21.177
- <sup>2</sup>Meets Requirements of USPC Class VI
- <sup>3</sup>Required for EHEDG Certification
- <sup>4</sup>Required for 3-A Certification
- <sup>5</sup>Meets Requirements of 1935/2004/EC

**SPECIALTY CODES**

- 0770 Saniflo HS
- 0771 Saniflo HS, w/Swivel Stand
- 0772 Saniflo HS, Wil-Gard 110V
- 0773 Saniflo HS, Wil-Gard 220V
- 0774 Saniflo HS, Wil-Gard 110V, w/Swivel Stand
- 0775 Saniflo HS, Wil-Gard 220V, w/Swivel Stand
- 0778 Saniflo HS, DIN Connection
- 0779 Saniflo HS, w/Swivel Stand DIN Connection
- 0780 Saniflo HS, Wil-Gard 110V DIN Connection
- 0781 Saniflo HS, Wil-Gard 220V DIN Connection
- 0782 Saniflo HS, Wil-Gard 110V, w/Swivel Stand DIN Connection
- 0783 Saniflo HS, Wil-Gard 220V, w/Swivel Stand DIN Connection
- 0784 Saniflo HS, SMS Connection
- 0785 Saniflo HS, w/Swivel Stand SMS Connection
- 0786 Saniflo HS, Wil-Gard 110V SMS Connection
- 0787 Saniflo HS, Wil-Gard 220V SMS Connection
- 0788 Saniflo HS, Wil-Gard 110V, w/Swivel Stand SMS Connection
- 0789 Saniflo HS, Wil-Gard 220V, w/Swivel Stand SMS Connection
- 0770E Saniflo HS (1935/2004/EC)
- 0771E Saniflo HS, w/Swivel Stand (1935/2004/EC)
- 0772E Saniflo HS, Wil-Gard 110V (1935/2004/EC)
- 0773E Saniflo HS, Wil-Gard 220V (1935/2004/EC)
- 0774E Saniflo HS, Wil-Gard 110V, w/Swivel Stand (1935/2004/EC)
- 0775E Saniflo HS, Wil-Gard 220V, w/Swivel Stand (1935/2004/EC)
- 0778E Saniflo HS, DIN Connection (1935/2004/EC)
- 0779E Saniflo HS, w/Swivel Stand DIN Connection (1935/2004/EC)
- 0780E Saniflo HS, Wil-Gard 110V DIN Connection (1935/2004/EC)
- 0781E Saniflo HS, Wil-Gard 220V DIN Connection (1935/2004/EC)
- 0782E Saniflo HS, Wil-Gard 110V, w/Swivel Stand DIN Connection (1935/2004/EC)
- 0783E Saniflo HS, Wil-Gard 220V, w/Swivel Stand DIN Connection (1935/2004/EC)
- 0784E Saniflo HS, SMS Connection (1935/2004/EC)
- 0785E Saniflo HS, w/Swivel Stand SMS Connection (1935/2004/EC)
- 0786E Saniflo HS, Wil-Gard 110V SMS Connection (1935/2004/EC)
- 0787E Saniflo HS, Wil-Gard 220V SMS Connection (1935/2004/EC)
- 0788E Saniflo HS, Wil-Gard 110V, w/Swivel Stand SMS Connection (1935/2004/EC)
- 0789E Saniflo HS, Wil-Gard 220V, w/Swivel Stand SMS Connection (1935/2004/EC)

**NOTE:** MOST ELASTOMERIC MATERIALS USE COLORED DOTS FOR IDENTIFICATION.  
Viton® is a registered trademark of DuPont Dow Elastomers.



HOW IT WORKS—PUMP

The Wilden diaphragm pump is an air-operated, positive displacement, self-priming pump. These drawings show flow pattern through the pump upon its initial stroke. It is assumed the pump has no fluid in it prior to its initial stroke.

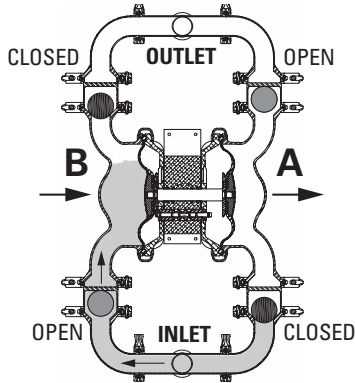

**FIGURE 1** The air valve directs pressurized air to the back side of diaphragm A. The compressed air is applied directly to the liquid column separated by elastomeric diaphragms. The diaphragm acts as a separation membrane between the compressed air and liquid; a balanced load removes mechanical stress from the diaphragm. The compressed air moves the diaphragm away from the center of the pump. The opposite diaphragm is pulled in by the shaft connected to the pressurized diaphragm. Diaphragm B is on its suction stroke; air behind the diaphragm has been forced out to atmosphere through the exhaust port of the pump. The movement of diaphragm B toward the center of the pump creates a vacuum within chamber B. Atmospheric pressure forces fluid into the inlet manifold forcing the inlet valve ball off its seat. Liquid is free to move past the inlet valve ball and fill the liquid chamber (see shaded area).

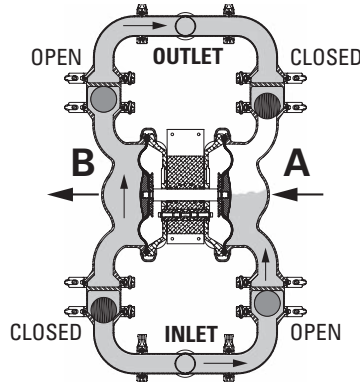

**FIGURE 2** When the pressurized diaphragm, diaphragm A, reaches the limit of its discharge stroke, the air valve redirects pressurized air to the back side of diaphragm B. The pressurized air forces diaphragm B away from the center while pulling diaphragm A to the center. Diaphragm B is now on its discharge stroke. Diaphragm B forces the inlet valve ball onto its seat due to the hydraulic forces developed in the liquid chamber and manifold of the pump. These same hydraulic forces lift the discharge valve ball off its seat, while the opposite discharge valve ball is forced onto its seat, forcing fluid to flow through the pump discharge. The movement of diaphragm A toward the center of the pump creates a vacuum within liquid chamber A. Atmospheric pressure forces fluid into the inlet manifold of the pump. The inlet valve ball is forced off its seat allowing the fluid being pumped to fill the liquid chamber.

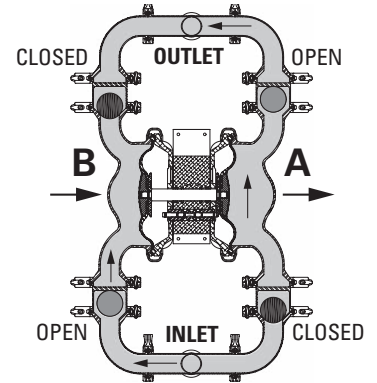

**FIGURE 3** At completion of the stroke, the air valve again redirects air to the back side of diaphragm A, which starts diaphragm B on its exhaust stroke. As the pump reaches its original starting point, each diaphragm has gone through one exhaust and one discharge stroke. This constitutes one complete pumping cycle. The pump may take several cycles to completely prime depending on the conditions of the application.



HOW IT WORKS—AIR DISTRIBUTION SYSTEM

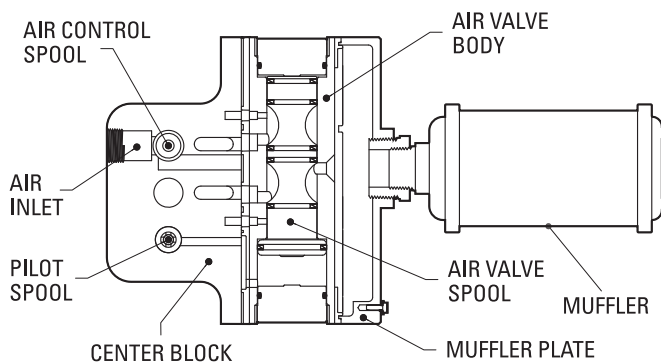

The heart of the patented Pro-Flo® SHIFT Air Distribution System (ADS) is the air valve assembly. The air valve design incorporates an unbalanced spool with the small end of the spool being pressurized continuously while the large end of the spool is alternately pressurized, then exhausted to move the spool. The air valve spool directs pressurized air to one chamber while exhausting the other. The air forces the main shaft/diaphragm assembly to move to one side – discharging liquid on that side and pulling liquid in on the other side. When the shaft reaches the end of the stroke, the inner piston actuates the pilot spool, which controls the air to the large end of the air valve spool. The repositioning of the air valve spool routes the air to the other air chamber. The air control spool allows air to flow freely into the air chamber for the majority of each pump stroke, but it significantly restricts the flow of air into the air chamber when activated by the inner piston near the end of the each stroke.





**DIMENSIONAL DRAWINGS**

**PS4 Saniflo™ HS Vertically-Mounted, Center-Ported with Ball/Mushroom Valve, Swivel Stand**

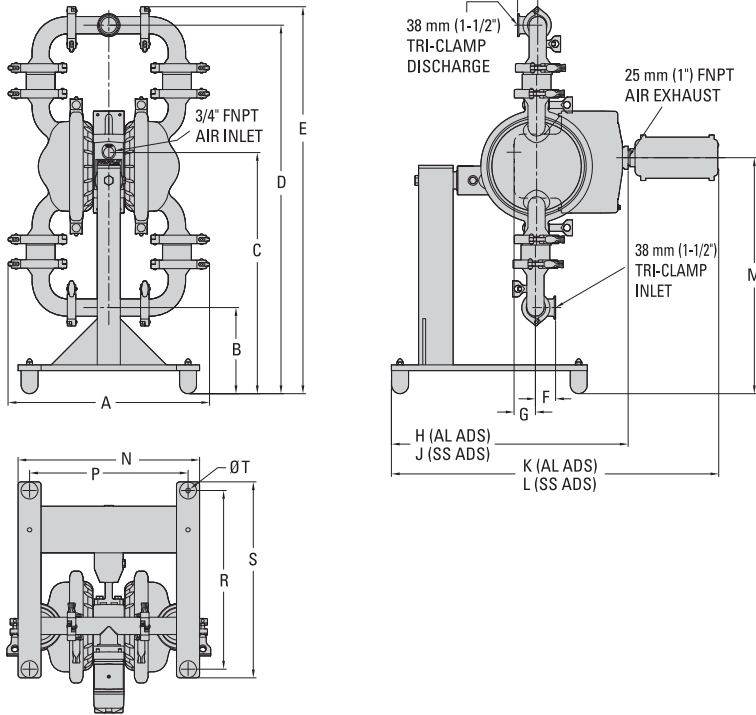

**DIMENSIONS**

ITEM	METRIC (mm)	STANDARD (inch)
A	440	17.5
B	190	7.5
C	531	20.9
D	812	32.0
E	853	33.6
F	45	1.8
G	47	1.9
H	522	20.5
J	514	20.3
K	721	28.4
L	715	28.2
M	520	20.5
N	400	15.8
P	349	13.8
R	394	15.5
S	432	17.0
T	Ø10	Ø0.4

LW0243 REV. C

**PS4 Saniflo™ HS Vertically-Mounted, Center-Ported with Ball/Mushroom Valve, Fixed Stand**

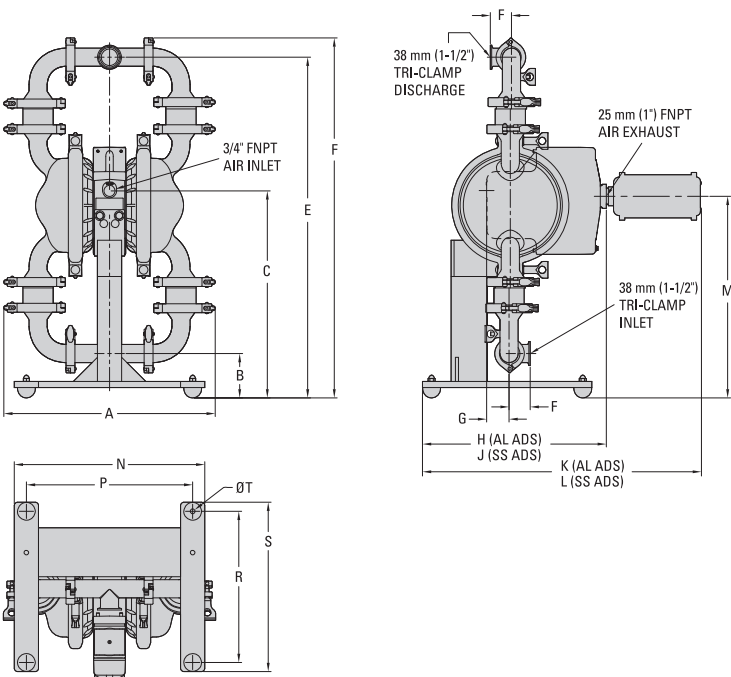

**DIMENSIONS**

ITEM	METRIC (mm)	STANDARD (inch)
A	440	17.5
B	93	3.7
C	435	17.1
D	716	28.2
E	757	29.8
F	45	1.8
G	47	1.9
H	386	15.2
J	380	15.0
K	586	23.1
L	580	22.9
M	423	16.7
N	400	15.8
P	349	13.8
R	318	12.5
S	356	14.0
T	Ø10	Ø0.4

LW0242 REV. C











## SUCTION-LIFT CURVES

### PS4 SANIFLO™ HS SUCTION-LIFT CAPABILITY

Suction-lift curves are calibrated for pumps operating at 305 m (1,000') above sea level. This chart is meant to be a guide only. There are many variables that can affect your pump's operating characteristics. The number of intake and discharge elbows, viscosity of pumping fluid, elevation (atmospheric pressure) and pipe friction loss all affect the amount of suction lift your pump will attain.

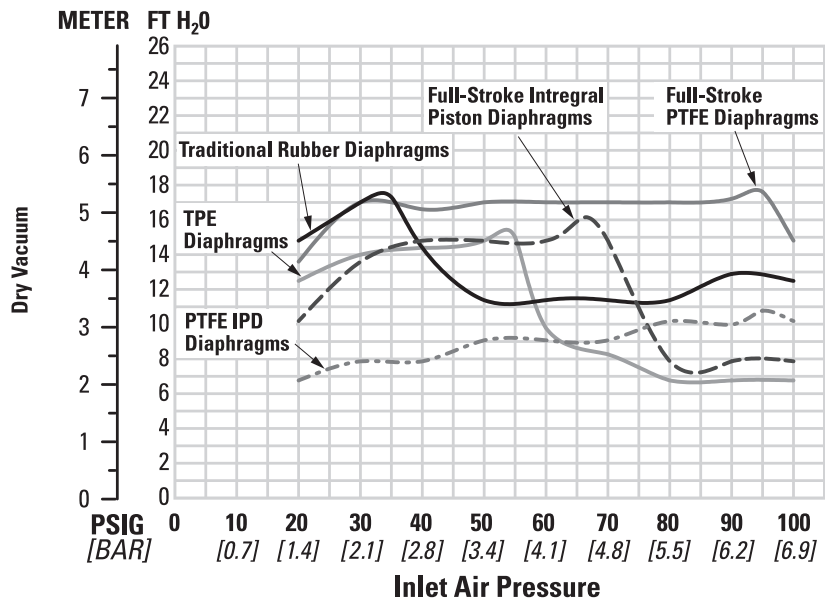



## SUGGESTED INSTALLATION

Wilden pumps are designed to meet the performance requirements of even the most demanding pumping applications. They have been designed and manufactured to the highest standards and are available in a variety of liquid path materials to meet your chemical resistance needs. Refer to the performance section of this manual for an in-depth analysis of the performance characteristics of your pump. Wilden offers the widest variety of elastomer options in the industry to satisfy temperature, chemical compatibility, abrasion-resistance and flex concerns.

The suction pipe size should be equivalent or larger than the diameter of the suction inlet on your Wilden pump. The suction hose must be non-collapsible, reinforced type as these pumps are capable of pulling a high vacuum. Discharge piping should also be equivalent or larger than the diameter of the pump discharge to minimize friction losses. It is critical that all fittings and connections are airtight or a reduction or loss of pump suction capability will result.

**INSTALLATION:** Months of careful planning, study and selection efforts can result in unsatisfactory pump performance if installation details are left to chance.

Premature failure and long-term dissatisfaction can be avoided if reasonable care is exercised throughout the installation process.

**LOCATION:** Noise, safety and other logistical factors usually dictate where equipment will be situated on the production floor. Multiple installations with conflicting requirements can result in congestion of utility areas, leaving few choices for additional pumps.

Within the framework of these and other existing conditions, every pump should be located in such a way that the following key factors are balanced against each other to maximum advantage.

**ACCESS:** First of all, the location should be accessible. If it is easy to reach the pump, maintenance personnel will have an easier time carrying out routine inspections and adjustments. Should major repairs become necessary, ease of access can play a key role in speeding the repair process and reducing total downtime.

**AIR SUPPLY:** Every pump location should have an air line large enough to supply the volume of air necessary to achieve the desired pumping rate. Do not exceed the maximum rated air pressure.

For best results, the pumps should use a 5 $\mu$  (micron) air filter, needle valve and regulator. The use of an air filter before the pump will ensure that the majority of any pipeline contaminants will be eliminated.

**SOLENOID OPERATION:** When operation is controlled by a solenoid valve in the air line, three-way valves should be used. This valve allows trapped air between the valve and the pump to bleed off which improves pump performance.

**MUFFLER:** Sound levels are reduced below OSHA specifications using the standard Wilden muffler. Other mufflers can be used to further reduce sound levels, but they usually reduce pump performance.

**ELEVATION:** Selecting a site that is well within the pump's dynamic lift capability will ensure that loss-of-prime issues will be eliminated. In addition, pump efficiency can be adversely affected if proper attention is not given to site location.

**PIPING:** Final determination of the pump site should not be made until the piping challenges of each possible location have been evaluated. The impact of current and future installations should be considered ahead of time to make sure that inadvertent restrictions are not created for any remaining sites.

The best choice possible will be a site involving the shortest and straightest hook-up of suction and discharge piping. Unnecessary elbows, bends and fittings should be avoided. Pipe sizes should be selected to keep friction losses within practical limits. All piping should be supported independently of the pump. In addition, the piping should be aligned to avoid placing stress on the pump fittings.

Flexible hoses can be installed to aid in absorbing the forces created by the natural reciprocating action of the pump. If the pump is to be bolted down to a solid location, a mounting pad placed between the pump and the foundation will assist in minimizing pump vibration. Flexible connections between the pump and rigid piping will also assist in minimizing pump vibration. If quick-closing valves are installed at any point in the discharge system, or if pulsation within a system becomes a problem, a surge suppressor (SD Equalizer®) should be installed to protect the pump, piping and gauges from surges and water hammer.

If the pump is to be used in a self-priming application, make sure that all connections are airtight and that the suction lift is within the model's capability. **NOTE:** Materials of construction and elastomer options have an effect on suction-lift parameters. Please refer to the performance section for specifics.

When pumps are installed in applications involving flooded suction or suction head pressures, a gate valve should be installed in the suction line to permit closing of the line for pump service.

Pumps in service with a positive suction head are most efficient when inlet pressure is limited to 0.5–0.7 bar (7–10 psig). Premature diaphragm failure may occur if positive suction is 0.7 bar (10 psig) and higher.

**SUBMERSIBLE APPLICATIONS:** Pro-Flo® SHIFT pumps can be used for submersible applications when using the Pro-Flo® SHIFT single-point exhaust (submersible) option.

**ALL WILDEN PUMPS ARE CAPABLE OF PASSING SOLIDS. A STRAINER SHOULD BE USED ON THE PUMP INTAKE TO ENSURE THAT THE PUMP'S RATED SOLIDS CAPACITY IS NOT EXCEEDED.**

**SUGGESTED INSTALLATION**

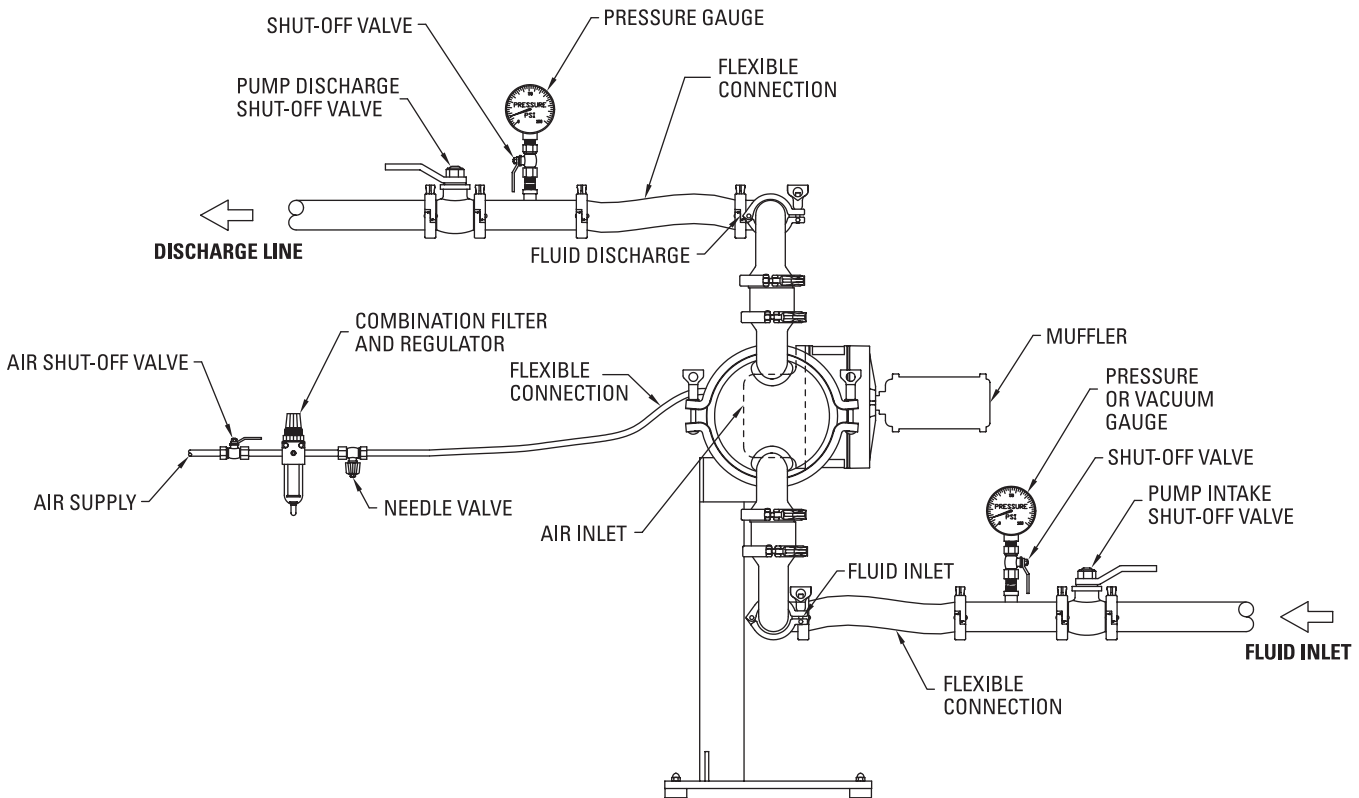

**NOTE:** In the event of a power failure, the air shut-off valve should be closed if restarting of the pump is not desirable once power is regained.

**AIR-OPERATED PUMPS:** To stop the pump from operating in an emergency situation, simply close the air shut-off valve (user-supplied) installed in the air supply line. A properly functioning valve will stop the air supply to the pump, therefore stopping output. This air shut-off valve should be located far enough away from the pumping equipment such that it can be reached safely in an emergency situation.

## SUGGESTED OPERATION & MAINTENANCE

**OPERATION:** The Pro-Flo® SHIFT pumps are pre-lubricated and do not require in-line lubrication. Additional lubrication will not damage the pump, however if the pump is heavily lubricated by an external source, the pump's internal lubrication may be washed away. If the pump is then moved to a non-lubricated location, it may need to be disassembled and re-lubricated as described in the DISASSEMBLY/REASSEMBLY INSTRUCTIONS.

Pump discharge rate can be controlled by limiting the volume and/or pressure of the air supply to the pump. An air regulator is used to regulate air pressure. A needle valve is used to regulate volume. Pump discharge rate can also be controlled by throttling the pump discharge by partially closing a valve in the discharge line—of the pump. This action increases friction loss which reduces flow rate. (See Section 5.) This is useful when the need exists to control the pump from a remote location. When the pump discharge pressure equals or exceeds the air supply pressure, the pump will stop; no bypass or pressure relief valve is needed, and pump damage will not occur. The pump has reached a “deadhead” situation and can be restarted by reducing the fluid

discharge pressure or increasing the air inlet pressure. The Wilden Pro-Flo® and Pro-Flo® SHIFT pumps run solely on compressed air and do not generate heat, therefore, your process fluid temperature will not be affected.

**MAINTENANCE AND INSPECTIONS:** Since each application is unique, maintenance schedules may be different for every pump. Frequency of use, line pressure, viscosity and abrasiveness of process fluid all affect the parts life of a Wilden pump. Periodic inspections have been found to offer the best means for preventing unscheduled pump downtime. Personnel familiar with the pump's construction and service should be informed of any abnormalities that are detected during operation.

**RECORDS:** When service is required, a record should be made of all necessary repairs and replacements. Over a period of time, such records can become a valuable tool for predicting and preventing future maintenance problems and unscheduled downtime. In addition, accurate records make it possible to identify pumps that are poorly suited to their applications.

## TROUBLESHOOTING

### ***Pump will not run or runs slowly.***

1. Ensure that the air inlet pressure is at least 0.4 bar (5 psig) above startup pressure and that the differential pressure (the difference between air inlet and liquid discharge pressures) is not less than 0.7 bar (10 psig).
2. Check air inlet filter for debris (see SUGGESTED INSTALLATION).
3. Check for extreme air leakage (blow by) that would indicate worn seals/bores in the air valve, pilot spool and main shaft.
4. Disassemble pump and check for obstructions in the air passageways or objects that would obstruct the movement of internal parts.
5. Check mating surfaces of flap valve assembly.
6. Check for sticking ball check valves. If material being pumped is not compatible with pump elastomers, swelling may occur. Replace ball check valves and seats with proper elastomers. Also, as the check valve balls wear out, they become smaller and can become stuck in the seats. In this case, replace balls and seats.
7. Check for broken inner pistons that could cause the air valve spool to be unable to shift.
8. Remove plug from pilot spool exhaust.

### ***Pump runs but little or no product flows.***

1. Check for pump cavitation; slow pump speed down to allow thick material to flow into liquid chambers.

2. Verify that vacuum required to lift liquid is not greater than the vapor pressure of the material being pumped (cavitation).
3. Check for sticking ball check valves. If material being pumped is not compatible with pump elastomers, swelling may occur. Replace ball check valves and seats with proper elastomers. Also, as the check valve balls wear out, they become smaller and can become stuck in the seats. In this case, replace balls and seats.

### ***Pump air valve freezes.***

1. Check for excessive moisture in compressed air. Either install a dryer or hot air generator for compressed air. Alternatively, a coalescing filter may be used to remove the water from the compressed air in some applications.

### ***Air bubbles in pump discharge.***

1. Check for ruptured diaphragm.
2. Check tightness of outer pistons (refer to Section 7).
3. Check tightness of fasteners and integrity of O-rings and seals, especially at intake manifold.
4. Ensure pipe connections are airtight.

### ***Product comes out air exhaust.***

1. Check for diaphragm rupture.
2. Check tightness of outer pistons to shaft.





## PUMP DISASSEMBLY

**Tools Required:**

- 1" Socket Wrench
- Vise equipped with soft jaws (such as plywood, plastic or other suitable material)

**CAUTION:** Before any maintenance or repair is attempted, the compressed air line to the pump should be disconnected and all air pressure allowed to bleed from the pump. Disconnect all intake, discharge and air lines. Drain the pump by turning it upside down and allowing any fluid to flow into a suitable container. Be aware of any hazardous effects of contact with your process fluid.

**NOTE:** The model photographed for these instructions incorporates PTFE diaphragms.

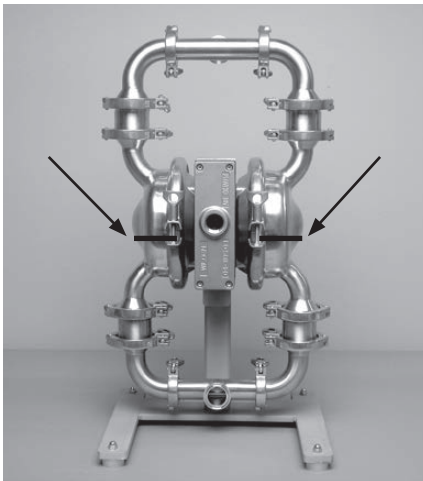
**Step 1**

Prior to assembly, place alignment marks on the liquid chambers and air chambers to assist with proper alignment during reassembly.

**Step 2**

Loosen the wing nut and remove both discharge manifold clamp bands.

**Step 3**

Remove the discharge manifold and manifold gaskets.



**Step 4**

Next, remove the clamp bands that secure the ball valve housing to the liquid chamber.



**Step 5A**

Next, remove the ball valve housing, valve ball and gasket.



**Step 5B**

If your pump is fitted with a mushroom valve, remove the mushroom valve housing, mushroom valve and gasket.



**Step 6**

Loosen the wing nut and remove the inlet manifold clamp bands.



**Step 7**

Next, remove the clamp bands that secure the ball valve housing to the liquid chamber.



**Step 8**

Next, remove the ball valve housing, valve ball and gasket from liquid chamber. To ensure proper alignment during reassembly of manifold/liquid chamber interface, turn off-set portion of valve housing to the left or to the right. This procedure works for the inlet manifold and discharge manifold connections.

WILDEN PUMP & ENGINEERING, LLC

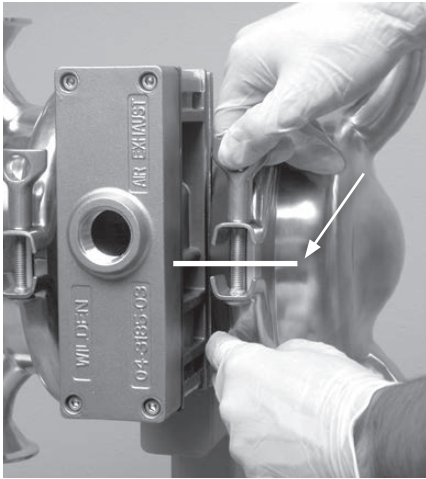

**Step 9**

Now the large clamp bands can be removed. **NOTE:** Prior to assembly, alignment marks should be placed on the liquid chambers and air chambers to assist with proper alignment during reassembly.

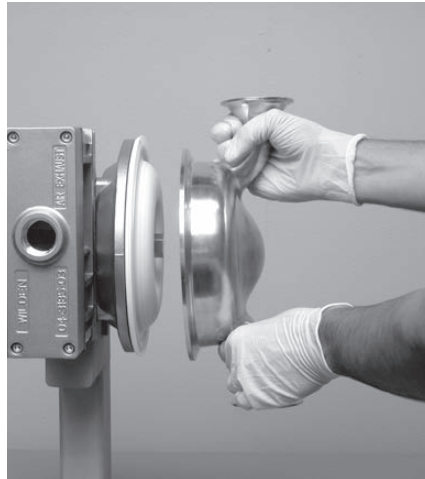

**Step 10A**

Next, remove the liquid chamber from the center section assembly.



**Step 10B**

If your pump is fitted with an integral piston diaphragm (IPD), when you remove the liquid chamber you will notice that there is no outer piston.



**Step 11A**

Using two (2) adjustable wrenches, turning in the opposite direction, loosen and remove one (1) of the two (2) outer pistons.



**Step 11B**

If your pump is fitted with an IPD, the procedure for removing the diaphragm is slightly different. In this case, simply grasp the diaphragm in two locations and turn in a counter-clockwise direction.



**Step 12A**

After loosening and removing the outer piston, the remaining diaphragm assembly and shaft can be removed from the center section assembly.

## PUMP DISASSEMBLY

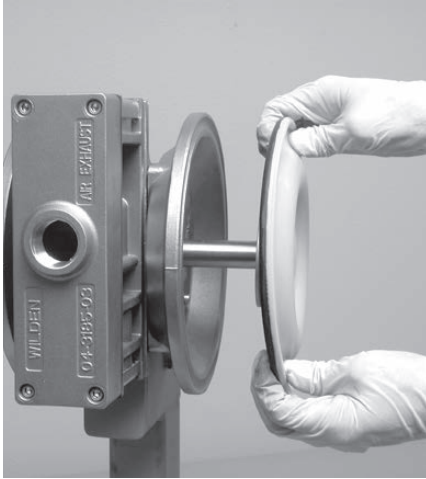

### Step 12B

If your pump is fitted with an IPD, the procedure for removing the diaphragm is the same.

## WIL-GARD™ DIAPHRAGM SENSOR

### Wil-Gard™ Diaphragm Sensor Removal



### Step 1

After removing the inlet and discharge manifold assemblies, disconnect the Wil-Gard™ module from the sensor wires.



### Step 2

Next, remove the large clamp bands and the liquid chamber on either side of the pump.



### Step 3

The Wil-Gard™ sensor cables can be easily removed from the diaphragm assembly by simply pulling them from between the primary and back-up diaphragm.



## WIL-GARD™ DIAPHRAGM SENSOR

### Wil-Gard™ Diaphragm Sensor Installation



#### Step 1

The Wil-Gard™ sensor wires must be installed between the primary diaphragm and the backup diaphragm, on both sides of the pump, at the six o'clock position. They should be positioned approximately half the distance to the shaft from the edge of the diaphragm.



#### Step 2

Prior to installing the liquid chamber, and after positioning the Wil-Gard™ sensor cable between the primary and back-up diaphragms, run the sensor cable along the diaphragm bead but outside the pump. Now install the liquid chamber and large clamp band.



#### Step 3

When installing the liquid chamber and large clamp band, route the Wil-Gard™ sensor cable to the inside of the large clamp band fastener. Next, reconnect the Wil-Gard™ module. **NOTE:** Use caution to ensure that the sensor wires are not damaged or pinched by the clamp band.

## SWIVEL PUMP STAND OPTION

For ease of maintenance and cleaning, Wilden offers an optional swivel pump stand. The swivel pump stand allows the pump to be drained by rotating the pump so that the fluid can flow out of the discharge and into a suitable container.

### Draining Pump Contents

To drain the pump of its contents, first disconnect the inlet and discharge connections. Next, loosen, but do not remove, the anti-rotation screw by turning counterclockwise two turns. After loosening the anti-rotation bolt, rotate pump 180°. This will allow the contents within the pump to flow out of the discharge and into a suitable container. After draining the pump, rotate the pump back to the upright position and tighten the anti-rotation bolt.

### Removing Pump From Swivel Pump Stand

Saniflo™ HS pumps are very heavy. It is recommended that the pump be disassembled while attached to the stand. If it is necessary to remove the pump from the stand while fully assembled, use a hoist or mechanical means to support the pump as it is removed from the stand.

To remove your Saniflo™ HS pump from the swivel pump stand, first loosen the anti-rotation bolt (item #1) by turning counter-clockwise. Next, ensure the entire pump weight is supported by hoist and loosen the locking pin (item #2) by turning counter-clockwise. This will allow the pump to be removed from the stand.

**CAUTION:** Removal of the locking pin (item #2) will allow the pump to fall from the stand, potentially causing injury to the operator or personnel in the immediate area. Never operate or store the pump without the locking pin (item #2) in place and properly torqued.

**NOTE:** The center block-to-bushing bolts (item #4) attach the center block mounting bushing (item #3) to the center block (not shown). These bolts do not need to be removed to remove the pump from the stand.

**NOTE:** Torque values are located in Section 7 of this manual.

**NOTE:** Item 5 and Item 6 are required for 3-A Certification.

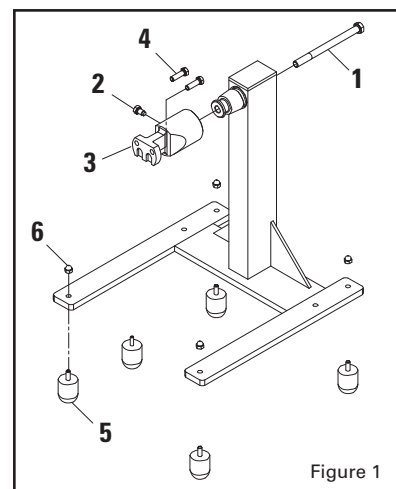

Figure 1



## AIR VALVE / CENTER SECTION DISASSEMBLY

### Tools Required:

- 1/4" Hex-Head Wrench
- 3/16" Hex-Head Wrench
- Snap-Ring Pliers
- O-Ring Pick

**CAUTION:** Before any maintenance or repair is attempted, the compressed air line to the pump should be disconnected and all air pressure allowed to bleed from the pump. Disconnect all intake, discharge and air lines. Drain the pump by turning it upside down and allowing any fluid to flow into a suitable container. Be aware of hazardous effects of contact with your process fluid.

The Wilden Pro-Flo® SHIFT metal pumps utilize a revolutionary Pro-Flo® SHIFT air distribution system. Proprietary composite seals reduce the coefficient of friction and allow the Pro-Flo® SHIFT to run lube-free. The Pro-Flo® SHIFT air distribution system is designed to perform in on/off, non-freezing, non-stalling, tough duty applications.



### Step 1

Using a pair of snap-ring pliers, remove the snap-ring from pilot sleeve.



### Step 2

Using an O-ring pick, remove O-ring from modulator spool.



### Step 3

Using the appropriate-sized wrench, loosen and remove the fasteners that attach the air chamber to center section.

## AIR VALVE / CENTER SECTION DISASSEMBLY

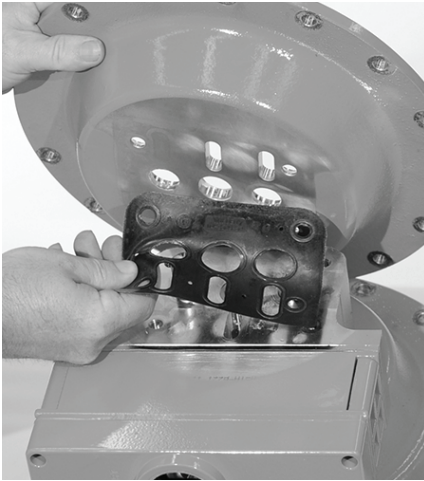

### Step 4

Lift away air chamber from center section and remove center block gasket. Replace gasket if necessary.



### Step 5

Turn assembly over and remove the pilot spool sleeve from the center section.

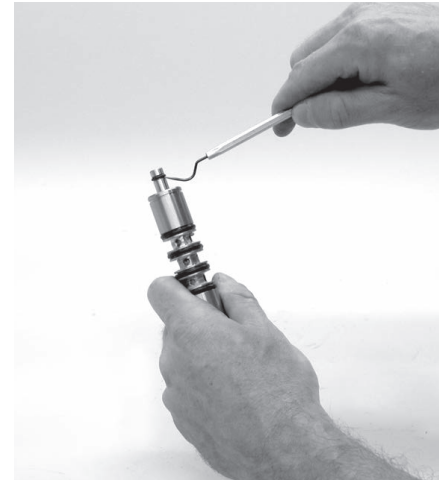

### Step 6

Using an O-ring pick, gently remove the O-ring from the opposite side of the dimpled end of the pilot spool.



### Step 7

Gently remove the pilot spool from the sleeve and inspect for nicks, wear or damage. Replace the pilot spool assembly or sleeve O-rings if necessary. During reassembly, never insert the dimpled end of the pilot spool first, this will damage the single urethane O-ring by passing it over the ports in the pilot sleeve.

**NOTE:** Seals should not be removed from the assembly. Seals are not sold separately.



### Step 8

Remove modulator spool from center section. Check for wear to spool or O-rings and replace if necessary.



### Step 9

Using the appropriate-sized wrench, loosen the fasteners and lift away remaining air chamber and center block gasket from center section. Replace gasket if necessary.

## AIR VALVE / CENTER SECTION DISASSEMBLY

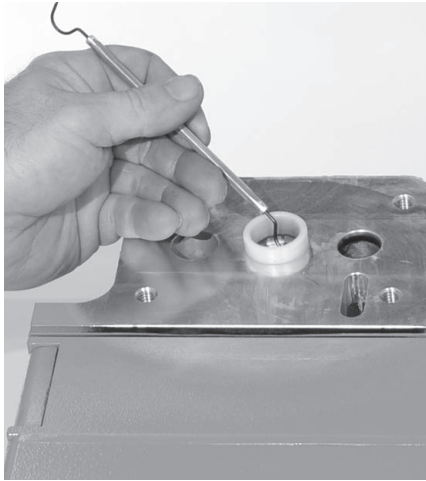

### Step 10

Using an O-ring pick, remove the two (2) shaft bushings from center block. Inspect and replace if necessary. Using an O-ring pick, gently remove the two (2) Glyd™ rings from the center block. Inspect and replace if necessary.

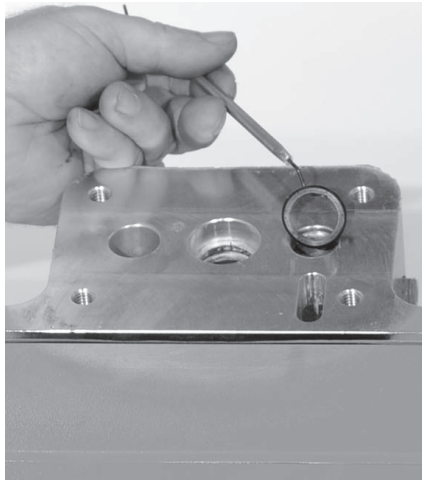

### Step 11

Using an O-ring pick, remove the two (2) Glyd™ rings from modulator spool bore. Inspect and replace if necessary.



### Step 12

Using an appropriate-sized wrench, remove the pilot exhaust muffler. Inspect for damage or contamination and replace if necessary.



### Step 13

Using an appropriate-sized hex wrench, loosen and remove the four (4) air valve bolts from center section assembly.

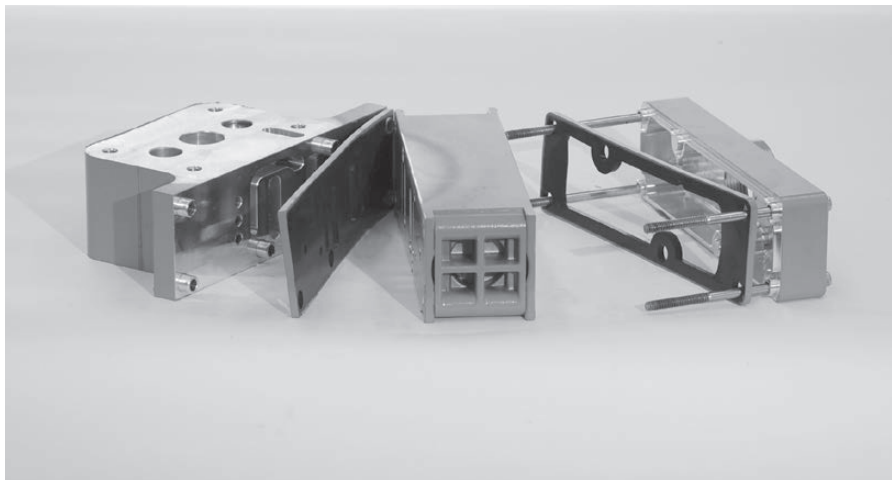

### Step 14

Lift away muffler plate and muffler plate gasket from center block. Inspect for wear and replace if necessary. Lift away the air valve assembly and remove air valve gasket. Inspect the gasket and replace if necessary.

## AIR VALVE / CENTER SECTION DISASSEMBLY

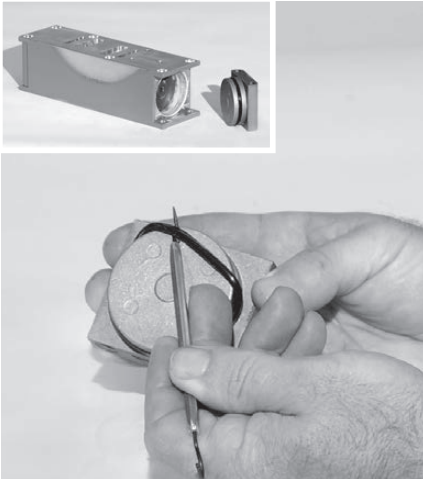

### Step 15

Remove air valve end cap to expose air valve spool by lifting up on end cap. Inspect O-ring on end cap using an O-ring pick. Replace O-ring(s) if necessary. **NOTE:** The Pro-Flo® SHIFT air valve incorporates an end cap at both ends of the air valve.

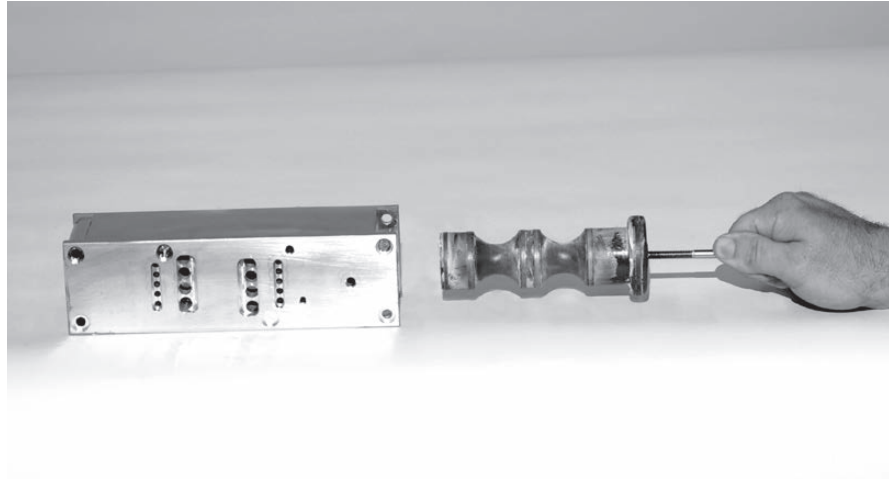

### Step 16

Remove the air valve spool from the air valve body by threading one air valve bolt into the end of the air valve spool and gently sliding the spool out of the air valve body. Inspect seals for signs of wear and replace the entire air valve assembly if necessary. Re-insert the spool immediately into air valve body after inspection as the seals expand and cannot be reinserted after a length of time.

**NOTE:** Seals should not be removed from the assembly. Seals are not sold separately.

## SINGLE-POINT EXHAUST PRO-FLO® SHIFT

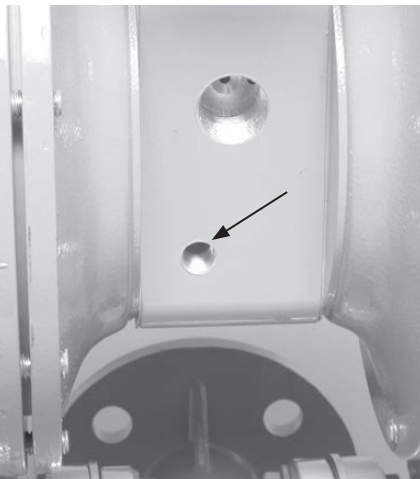

### Step 1

Remove pilot exhaust muffler in pilot bleed port located at the front of the center block. Install 1/4" NPT pipe plug (00-7010-08) into bleed port.



### Step 2

Next, install an optional single-point exhaust gasket (04-2638-52). The single-point air valve gasket can be purchased as a spare part or included with the purchase of a new Pro-Flo® SHIFT pump.



## REASSEMBLY HINTS & TIPS

### ASSEMBLY:

Upon performing applicable maintenance to the air distribution system, the pump can now be reassembled. Please refer to the disassembly instructions for photos and parts placement. To reassemble the pump, follow the disassembly instructions in reverse order. The air distribution system needs to be assembled first, then the diaphragms and finally the wetted path. The following tips will assist in the assembly process.

- Lubricate air valve bore, center section shaft and pilot spool bore with NLGI grade 2 white EP bearing grease or equivalent.
- Clean the inside of the center section shaft bore to ensure no damage is done to new shaft seals.
- A small amount of NLGI grade 2 white EP bearing grease can be applied to the muffler and air valve gaskets to lubricate gaskets during assembly.
- Make sure that the exhaust port on the muffler plate is centered between the two exhaust ports on the center section.
- Stainless steel bolts should be lubed to reduce the possibility of seizing during tightening.
- Use a mallet to tap lightly on the large clamp bands to seat the diaphragm before tightening.

### MAXIMUM TORQUE SPECIFICATIONS

Description of Part	Max. Torque
Air Valve	13.6 N·m (120 in-lb)
Air Chamber Bolts	27.1 N·m (20 ft-lb)
Outer Pistons, All	54.2 N·m (40 ft-lb)
Center Block-to-Stand Bolt	44.7 N·m (33 ft-lb)
Center Block-to-Bushing Bolt	44.7 N·m (33 ft-lb)
Locking Pin	44.7 N·m (33 ft-lb)
Anti-Rotation Bolt	67.8 N·m (50 ft-lb)

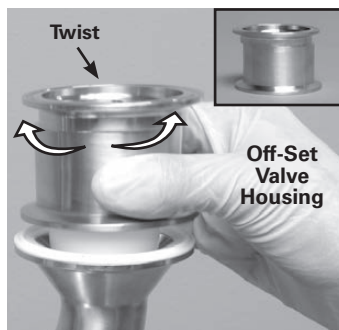

**NOTE:** To ensure proper alignment during reassembly of manifold/liquid chamber interface, turn off-set portion of valve housing to the left or to the right. This procedure works for the inlet manifold and discharge manifold connections.

### SHAFT SEAL INSTALLATION:

#### PRE-INSTALLATION

- Once all of the old seals have been removed, the inside of the bushing should be cleaned to ensure no debris is left that may cause premature damage to the new seals.

#### INSTALLATION

The following tools can be used to aid in the installation of the new seals:

Needle-Nose Pliers  
Phillips Screwdriver  
Electrical Tape

- Wrap electrical tape around each leg of the needle-nose pliers (heat shrink tubing may also be used). This is done to prevent damaging the inside surface of the new seal.
- With a new seal in hand, place the two legs of the needle-nose pliers inside the seal ring. (See Figure A.)
- Open the pliers as wide as the seal diameter will allow, then with two fingers pull down on the top portion of the seal to form kidney shape. (See Figure B.)
- Lightly clamp the pliers together to hold the seal into the kidney shape. Be sure to pull the seal into as tight of a kidney shape as possible, this will allow the seal to travel down the bushing bore easier.
- With the seal clamped in the pliers, insert the seal into the bushing bore and position the bottom of the seal into the correct groove. Once the bottom of the seal is seated in the groove, release the clamp pressure on the pliers. This will allow the seal to partially snap back to its original shape.
- After the pliers are removed, you will notice a slight bump in the seal shape. Before the seal can be properly resized, the bump in the seal should be removed as much as possible. This can be done with either the Phillips screwdriver or your finger. With either the side of the screwdriver or your finger, apply light pressure to the peak of the bump. This pressure will cause the bump to be almost completely eliminated.
- Lubricate the edge of the shaft with NLGI grade 2 white EP bearing grease.
- Slowly insert the center shaft with a rotating motion. This will complete the resizing of the seal.
- Perform these steps for the remaining seals.

**Figure A**

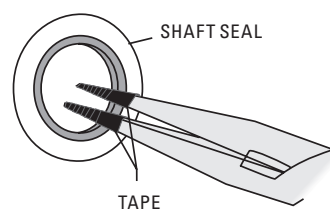

**Figure B**

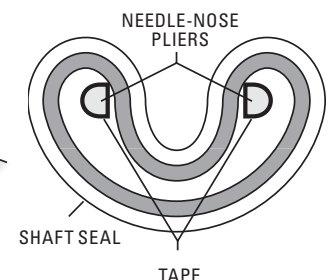





## CLEAN-IN-PLACE - CIP

The design of the PS4 HS pump allows for ease of cleaning and can be cleaned in place without disassembly. Before any cleaning is attempted, ensure that the cleaning fluids are compatible with all wetted components.

***For best cleaning results, consider the following information prior to cleaning the PS4 HS pump.***

- For best Clean-In-Place (CIP) results, the pump should be configured to either the EHEDG or 3-A configurations.
- Actual CIP effectiveness with pump user's product(s) and processes should be validated on location by the end user's quality assurance personnel to meet internal guidelines. Post-cleaning swab test is one method to accomplish this.
- The pump user should establish periodic inspections with full tear-down to verify that the CIP processes continue to be effective as first validated.
- Inlet pressure to the pump should not be greater than 0.7 bar (10 psig). Premature diaphragm failure may occur if greater than 0.7 bar (10 psig) is applied. If the pump is to be subjected to greater than 0.7 bar (10 psig), an optional diaphragm balancing device is suggested to eliminate the possibility of the diaphragms being forced against the air chamber and subsequently causing premature diaphragm failure.

***The following are some details to consider when cleaning the PS4 HS pump.***

- Through the EHEDG certification process, the PS4 HS pump has been validated to clean equivalent to the inlet tubing of the same diameter. The cleaning chemical supplier should be consulted and advised of this for their chemical solution and application. The same guidelines for duration of cleaning cycle and temperature of cleaning fluid apply.

- Suggested flow rate for the PS4 HS pump is 11 m<sup>3</sup>/h (50 gpm). Typically, higher is better.
- Typical CIP temperature is 77°C to 82°C (170°F to 180°F).
- Typical chemicals include NaOH (sodium hydroxide) caustic for wash and light acid and sanitizers for rinse.
- Once an initial CIP regimen is established, it may need to be modified to accommodate specific process and product differences or requirements. The most common adjustments include:
  - Changing cleaning time (extended or reduced pre-rinse, wash, rinses)
  - Changing cleaning flow rate
- The cleaning variables are related so that a pump user may be able to reduce the cleaning time by increasing the flow rate or chemical mix.
- Chlorinated sanitizers are known to cause premature failure of stainless steel and should be avoided.

### ***To Clean Pump***

- Activate the CIP system while slowly cycling the pump.

**NOTE:** A typical the CIP temperature limit is 90°C (195°F).

**NOTES**



**EXPLODED VIEW & PARTS LISTING**

**PS4 SANIFLO™ HS**

**EXPLODED VIEW**

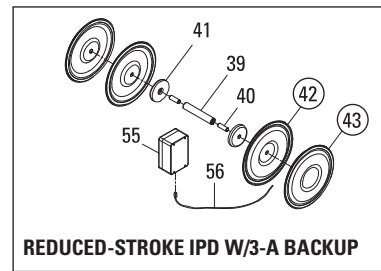
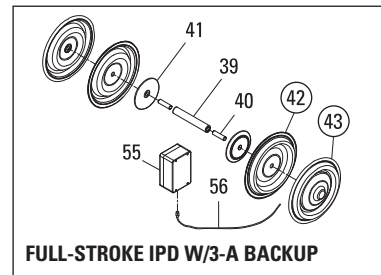
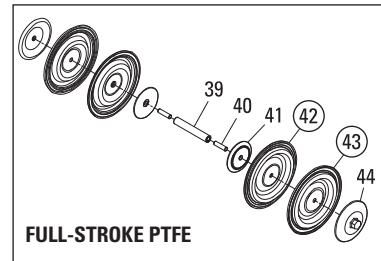
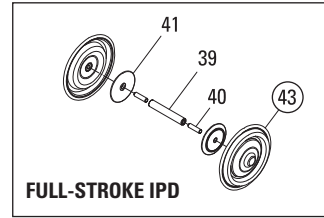
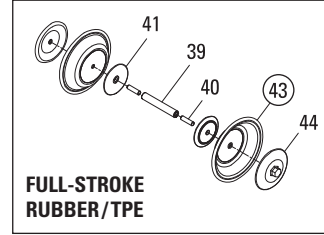
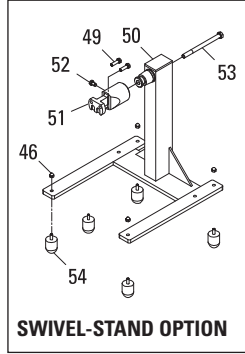
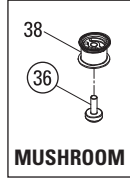
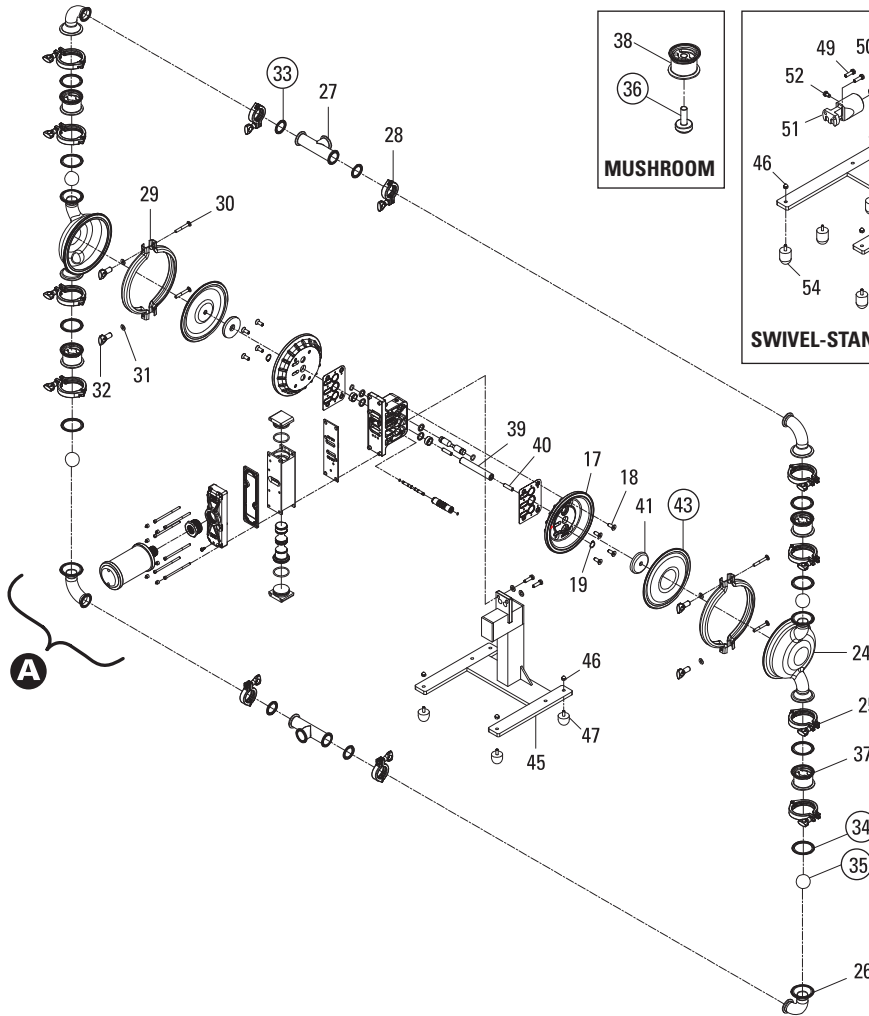

**A**

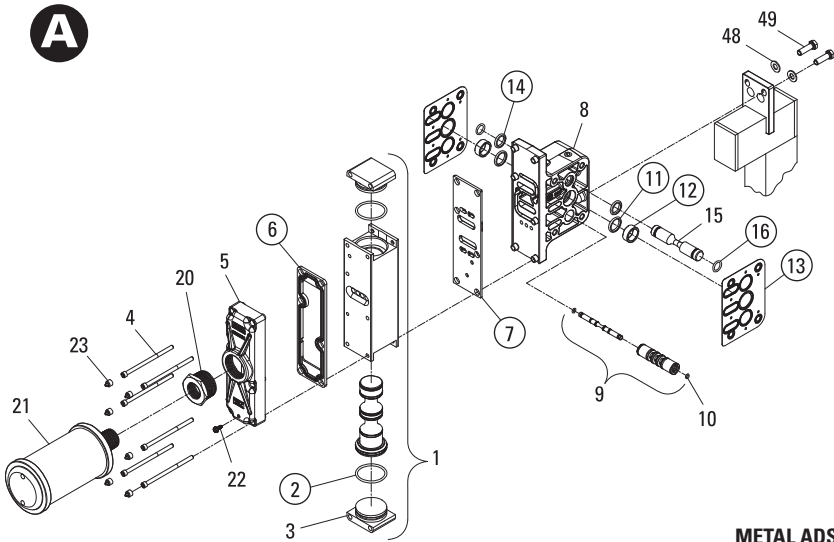

LW0244 REV. D



**EXPLODED VIEW & PARTS LISTING**

**PS4 SANIFLO™ HS**

**PARTS LISTING**

Item	Description	QTY	NICKEL PLATED ADS			STAINLESS STEEL ADS		
			PS4 HS P/N	PS4 HS EHEDG P/N	PS4 HS 3-A P/N	PS4 HS P/N	PS4 HS EHEDG P/N	PS4 HS 3-A P/N
<b>AIR DISTRIBUTION COMPONENTS</b>								
1	Air Valve Assembly, Pro-Flo® SHIFT <sup>1</sup>	1	04-2039-06	04-2039-06	04-2039-06	04-2039-03	04-2039-03	04-2039-03
2	O-Ring, End Cap (-225, Ø1.858" x Ø.139")	2	04-2390-52-700	04-2390-52-700	04-2390-52-700	04-2390-52-700	04-2390-52-700	04-2390-52-700
3	End Cap, Pro-Flo V™	2	04-2340-06	04-2340-06	04-2340-06	04-2340-03	04-2340-03	04-2340-03
4	Screw, SHC, Air Valve (1/4"-20 X 4-1/2")	4	N/A	N/A	N/A	01-6000-03	01-6000-03	01-6000-03
	Screw, SHC, Air Valve (1/4"-20 X 4-1/2")	6	01-6000-03	01-6000-03	01-6000-03	N/A	N/A	N/A
5	Muffler Plate, Pro-Flo® SHIFT	1	04-3189-06	04-3189-06	04-3189-06	04-3189-03	04-3189-03	04-3189-03
6	Gasket, Muffler Plate, Pro-Flo® SHIFT	1	04-3509-52	04-3509-52	04-3509-52	04-3509-52	04-3509-52	04-3509-52
7	Gasket, Air Valve, Pro-Flo® SHIFT	1	04-2639-52	04-2639-52	04-2639-52	04-2639-52	04-2639-52	04-2639-52
8	Center Block Assembly, Pro-Flo® SHIFT <sup>2,3</sup>	1	04-3129-06	04-3129-06	04-3129-06	04-3129-03	04-3129-03	04-3129-03
9	Removable Pilot Sleeve Assembly	1	04-3880-99	04-3880-99	04-3880-99	04-3880-99	04-3880-99	04-3880-99
10	Pilot Spool Retaining O-Ring (-009, Ø.208" x Ø.070")	2	04-2650-49-700	04-2650-49-700	04-2650-49-700	04-2650-49-700	04-2650-49-700	04-2650-49-700
11	Shaft Seal	2	08-3210-55-225	08-3210-55-225	08-3210-55-225	08-3210-55-225	08-3210-55-225	08-3210-55-225
12	Bushing, Shaft	2	08-3306-13	08-3306-13	08-3306-13	08-3306-13	08-3306-13	08-3306-13
13	Gasket, Center Block, Pro-Flo® SHIFT	2	04-3529-56	04-3529-56	04-3529-56	04-3529-56	04-3529-56	04-3529-56
14	O-Ring, (-210, Ø.734" x Ø.139")	2	04-3209-49	04-3209-49	04-3209-49	04-3209-49	04-3209-49	04-3209-49
15	Air Control Spool	1	04-3859-03	04-3859-03	04-3859-03	04-3859-03	04-3859-03	04-3859-03
16	Air Control Spool Retaining O-Ring (-114, Ø.612" x Ø.103")	2	04-3879-50	04-3879-50	04-3879-50	04-3879-50	04-3879-50	04-3879-50
17	Air Chamber, Pro-Flo V™	2	04-3660-06	04-3660-06	04-3660-06	04-3660-03	04-3660-03	04-3660-03
18	Screw, HSFHS, (3/8"-16 x 1")	8	71-6250-03	71-6250-03	71-6250-03	71-6250-03	71-6250-03	71-6250-03
19	Retaining Ring	2	04-3890-03	04-3890-03	04-3890-03	04-3890-03	04-3890-03	04-3890-03
20	Bushing, Reducer, 1-1/2" MNPT to 1" FNPT	1	04-6959-03	04-6959-03	04-6959-03	04-6959-03	04-6959-03	04-6959-03
21	Muffler, 1" MNPT	1	15-3510-06R	15-3510-06R	15-3510-06R	15-3510-06R	15-3510-06R	15-3510-06R
22	Grounding Screw, (10-32 x 1/2") Self Tapping	1	04-6345-08	04-6345-08	04-6345-08	04-6345-08	04-6345-08	04-6345-08
23	Plug, 1/4" SHCS (3-A)	4	N/A	N/A	N/A	N/A	N/A	02-7825-17
	Plug, 1/4" SHCS (3-A)	6	N/A	N/A	02-7825-17	N/A	N/A	N/A
<b>WETTED PATH COMPONENTS</b>								
▲ 24	Chamber, Liquid CIP 1-1/2" EHEDG	2	04-5000-10-385P	04-5000-10-385P	04-5000-10-385P	04-5000-10-385P	04-5000-10-385P	04-5000-10-385P
25	Clamp Band Assy, 2-1/2"	8	04-7104-03	04-7104-03	04-7104-03	04-7104-03	04-7104-03	04-7104-03
▲ 26	Elbow, 1-1/2" EHEDG	4	04-5240-10-385P	04-5240-10-385P	04-5240-10-385P	04-5240-10-385P	04-5240-10-385P	04-5240-10-385P
▲ 27	T-Section, 1-1/2" EHEDG	2	04-5160-10-385P	04-5160-10-385P	04-5160-10-385P	04-5160-10-385P	04-5160-10-385P	04-5160-10-385P
	T-Section, 1-1/2" EHEDG DIN	2	04-5160-10-386P	04-5160-10-386P	N/A	04-5160-10-386P	04-5160-10-386P	N/A
	T-Section, 1-1/2" EHEDG SMS	2	04-5160-10-387P	04-5160-10-387P	N/A	04-5160-10-387P	04-5160-10-387P	N/A
28	Clamp Band, Assy, Small	4	02-7100-03-85	02-7100-03-85	02-7100-03-85	02-7100-03-85	02-7100-03-85	02-7100-03-85
29	Clamp Band Assy, Large	2	04-7330-03-385	04-7330-03-385	04-7330-03-385	04-7330-03-385	04-7330-03-385	04-7330-03-385
30	Bolt, RHSN, 5/16"-18 X 2-1/2"	4	04-6070-03	04-6070-03	04-6070-03	04-6070-03	04-6070-03	04-6070-03
31	Washer, (Ø.343 X Ø.750 X .05)	4	01-6732-03	01-6732-03	01-6732-03	01-6732-03	01-6732-03	01-6732-03
32	Wing Nut, Medium Clamp	4	08-6661-10	08-6661-10	08-6661-10	08-6661-10	08-6661-10	08-6661-10
<b>GASKETS/VALVE BALLS/MUSHROOM VALVE</b>								
▲ 33	Gasket, 1-1/2"	4	*	*	*	*	*	*
▲ 34	Gasket, 2-1/2"	8	*	*	*	*	*	*
▲ 35	Valve Ball	4	*	*	*	*	*	*
▲ 36	Mushroom Valve	4	04-1096-55	N/A	N/A	04-1096-55	N/A	N/A
<b>CHECK VALVE COMPONENTS</b>								
▲ 37	Ball Cage, 1-1/2" EHEDG	4	04-5350-10-385P	04-5350-10-385P	04-5350-10-385P	04-5350-10-385P	04-5350-10-385P	04-5350-10-385P
▲ 38	Mushroom Valve Housing	4	04-5431-10-385P	N/A	N/A	04-5431-10-385P	N/A	N/A
<b>FULL-STROKE RUBBER/TPE/PTFE/FSIPD COMPONENTS</b>								
39	Shaft, Pro-Flo™, Non-PTFE	1	04-3800-03-700	04-3800-03-700	04-3800-03-700	04-3800-03-700	04-3800-03-700	04-3800-03-700
40	Shaft Stud, 1/2"-20 X 1-7/8"	2	08-6150-08	08-6150-08	08-6150-08	08-6150-08	08-6150-08	08-6150-08
41	Piston, Inner, P4 (Non-PTFE)	2	04-3700-01-700	04-3700-01-700	04-3700-01-700	04-3700-01-700	04-3700-01-700	04-3700-01-700
42	Diaphragm, Full-Stroke PTFE, Backup	2	*	N/A	N/A	*	N/A	N/A
	Diaphragm, Full-Stroke IPD, Backup (3-A)	2	N/A	N/A	04-1061-55	N/A	N/A	04-1061-55
▲ 43	Diaphragm, Primary	2	*	N/A	N/A	*	N/A	N/A
	Diaphragm, Full-Stroke PTFE, Primary	2	04-1040-55	N/A	N/A	04-1040-55	N/A	N/A
	Diaphragm, Full-Stroke IPD, Primary	2	N/A	04-1031-57	04-1031-57	N/A	04-1031-57	04-1031-57
▲ 44	Piston, Outer, (Non-PTFE)	2	04-4550-10-385P	N/A	N/A	04-4550-10-385P	N/A	N/A

LDW0245 Rev. D

\*Refer to Elastomer Chart.

▲ Product Contact Components.

<sup>1</sup>Includes: items 2 and 3.

<sup>2</sup>Includes: items 11, 12 and 14.

<sup>3</sup>Includes: items 46 and 47.

<sup>4</sup>Includes: items 46, 51, 52, 53 and 54.

All boldface items are primary wear parts.



**EXPLODED VIEW & PARTS LISTING (CON'T)**

**PS4 SANIFLO™ HS**

**EXPLODED VIEW**

Item	Description	QTY	NICKEL PLATED ADS			STAINLESS STEEL ADS		
			PS4 HS P/N	PS4 HS EHEDG P/N	PS4 HS 3-A P/N	PS4 HS P/N	PS4 HS EHEDG P/N	PS4 HS 3-A P/N
<b>REDUCED-STROKE SIPD COMPONENTS</b>								
39	Shaft, Pro-Flo™	1	04-3820-03-700	04-3820-03-700	04-3820-03-700	04-3820-03-700	04-3820-03-700	04-3820-03-700
40	Shaft Stud, 1/2"-20 X 1-7/8"	2	08-6150-08	08-6150-08	08-6150-08	08-6150-08	08-6150-08	08-6150-08
41	Piston, Inner, 1-1/2" EHEDG	2	04-3755-01	04-3755-01	04-3755-01	04-3755-01	04-3755-01	04-3755-01
<b>42</b>	<b>Diaphragm, Backup, IPD (3-A)</b>	<b>2</b>	<b>N/A</b>	<b>N/A</b>	<b>04-1060-55</b>	<b>N/A</b>	<b>N/A</b>	<b>04-1060-55</b>
<b>▲ 43</b>	<b>Diaphragm, Integral Piston</b>	<b>2</b>	<b>04-1030-72</b>	<b>04-1030-72</b>	<b>04-1030-72</b>	<b>04-1030-72</b>	<b>04-1030-72</b>	<b>04-1030-72</b>
<b>FIXED-STAND COMPONENTS</b>								
45	Stand, Pump, PV Assy. <sup>3</sup>	1	04-7654-03	04-7654-03	N/A	04-7654-03	04-7654-03	N/A
46	Nut, Cap, 5/16"-18, Pump Stand	4	08-6600-03-72	08-6600-03-72	08-6600-03-72	08-6600-03-72	08-6600-03-72	08-6600-03-72
47	Pad, Pump Stand	4	08-7670-20	08-7670-20	N/A	08-7670-20	08-7670-20	N/A
48	Washer, Flat (Ø.406 X Ø.812 X .065)	2	04-6740-03	04-6740-03	N/A	04-6740-03	04-6740-03	N/A
49	Screw, HHC, 3/8"-16 X 1-1/4"	2	04-6190-03	04-6190-03	04-6190-03	04-6190-03	04-6190-03	04-6190-03
<b>SWIVEL-STAND COMPONENTS</b>								
50	Pump Stand, Swivel, Assy. <sup>4</sup> (3-A)	1	04-7655-03	04-7655-03	04-7655-03	04-7655-03	04-7655-03	04-7655-03
51	Bushing, Center Block Mounting	1	15-7667-03	15-7667-03	15-7667-03	15-7667-03	15-7667-03	15-7667-03
52	Locking Pin	1	08-7694-03	08-7694-03	08-7694-03	08-7694-03	08-7694-03	08-7694-03
53	Screw, HHC, 1/2"-13 X 6"	1	15-6143-03	15-6143-03	15-6143-03	15-6143-03	15-6143-03	15-6143-03
49	Screw, HHC, 3/8"-16 X 1-1/4"	2	04-6190-03	04-6190-03	04-6190-03	04-6190-03	04-6190-03	04-6190-03
46	Nut, Cap, 5/16"-18, Pump Stand	4	08-6600-03-72	08-6600-03-72	08-6600-03-72	08-6600-03-72	08-6600-03-72	08-6600-03-72
54	Pad, Pump Stand 2" (3-A)	4	08-7672-20	08-7672-20	08-7672-20	08-7672-20	08-7672-20	08-7672-20
<b>ACCESSORY COMPONENTS</b>								
55	Control Module, Wil-Gard III, (3-A)	1	65-8015-99	65-8015-99	65-8015-99	65-8015-99	65-8015-99	65-8015-99
56	Sensor Cables, Wil-Gard II (3-A)	1	65-8020-99	65-8020-99	65-8020-99	65-8020-99	65-8020-99	65-8020-99

LW0245 Rev. D

\*Refer to Elastomer Chart.

▲ Product Contact Components.

<sup>1</sup>Includes: items 2 and 3.

<sup>2</sup>Includes: items 11, 12 and 14.

<sup>3</sup>Includes: items 46 and 47.

<sup>4</sup>Includes: items 46, 51, 52, 53 and 54.

**All boldface items are primary wear parts.**



**NOTES**

**EXPLODED VIEW & PARTS LISTING**

**PS4 SANIFLO™ HS**

1935/2004/EC

**EXPLODED VIEW**

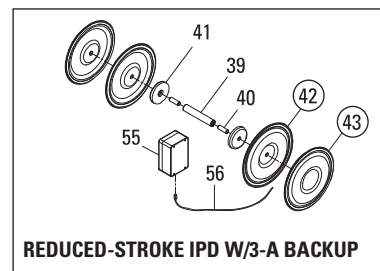
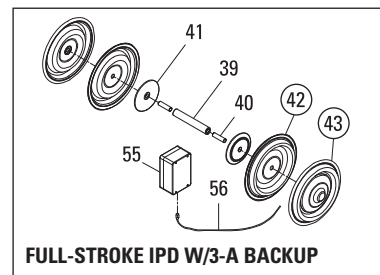
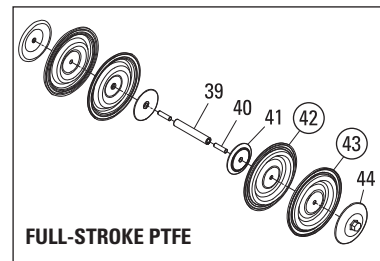
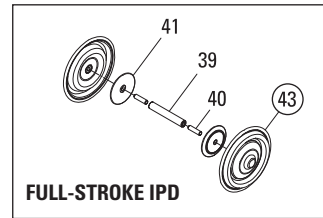
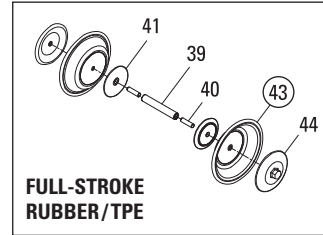
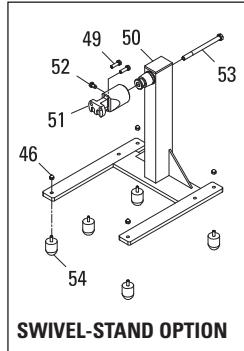
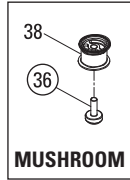
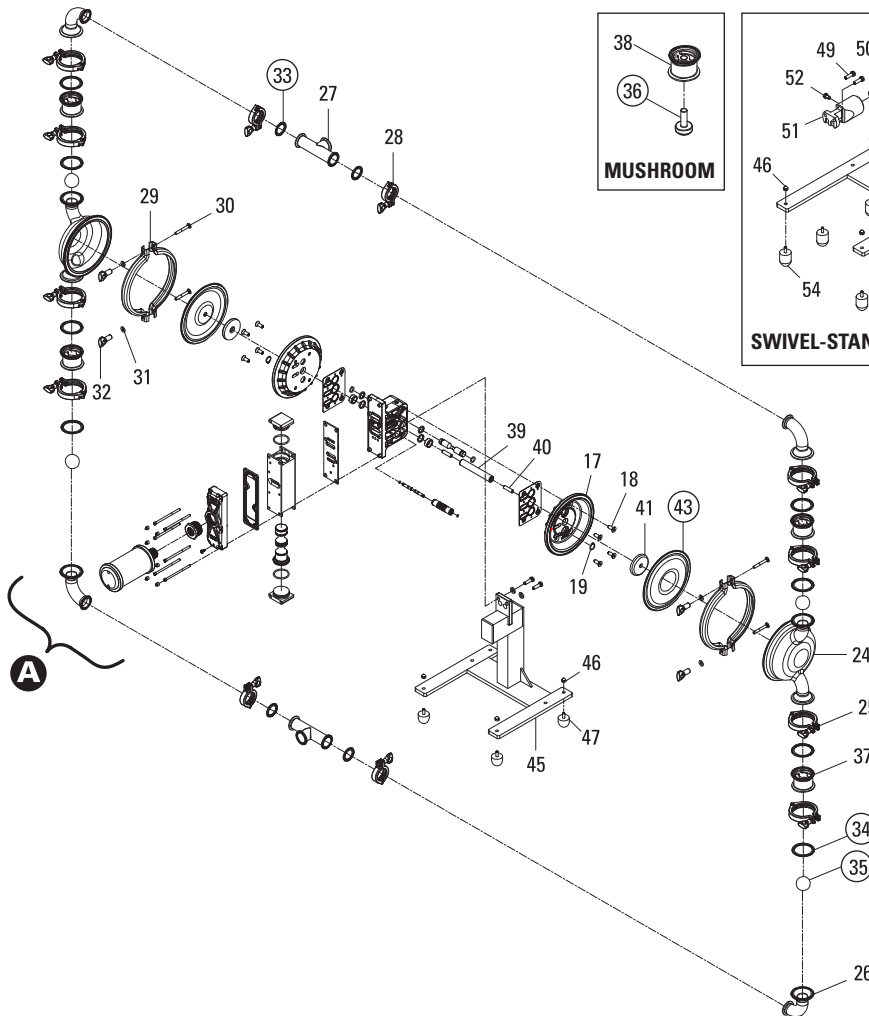

**A**

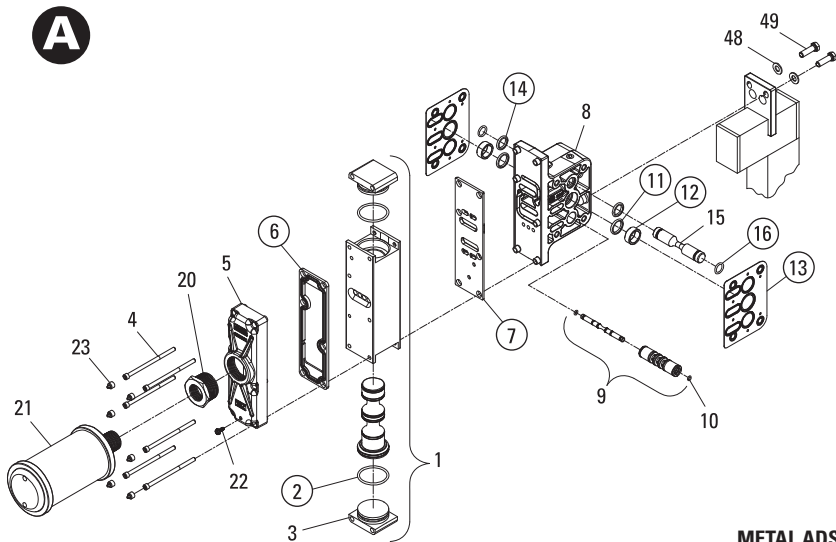

LW0244 REV. D



# EXPLODED VIEW & PARTS LISTING

**WILDEN**

**PS4 SANIFLO™ HS**

1935/2004/EC

**PARTS LISTING**

Item	Description	QTY	NICKEL PLATED ADS			STAINLESS STEEL ADS		
			PS4 HS P/N	PS4 HS EHEDG P/N	PS4 HS 3-A P/N	PS4 HS P/N	PS4 HS EHEDG P/N	PS4 HS 3-A P/N
<b>AIR DISTRIBUTION COMPONENTS</b>								
1	Air Valve Assembly, Pro-Flo® SHIFT <sup>1</sup>	1	04-2039-06	04-2039-06	04-2039-06	04-2039-03	04-2039-03	04-2039-03
2	O-Ring, End Cap (-225, Ø1.858" x Ø.139")	2	04-2390-52-700	04-2390-52-700	04-2390-52-700	04-2390-52-700	04-2390-52-700	04-2390-52-700
3	End Cap, Pro-Flo V™	2	04-2340-06	04-2340-06	04-2340-06	04-2340-03	04-2340-03	04-2340-03
4	Screw, SHC, Air Valve (1/4"-20 X 4-1/2")	4	N/A	N/A	N/A	01-6000-03	01-6000-03	01-6000-03
	Screw, SHC, Air Valve (1/4"-20 X 4-1/2")	6	01-6000-03	01-6000-03	01-6000-03	N/A	N/A	N/A
5	Muffler Plate, Pro-Flo® SHIFT	1	04-3189-06	04-3189-06	04-3189-06	04-3189-03	04-3189-03	04-3189-03
6	Gasket, Muffler Plate, Pro-Flo® SHIFT	1	04-3509-52	04-3509-52	04-3509-52	04-3509-52	04-3509-52	04-3509-52
7	Gasket, Air Valve, Pro-Flo® SHIFT	1	04-2639-52	04-2639-52	04-2639-52	04-2639-52	04-2639-52	04-2639-52
8	Center Block Assembly, Pro-Flo® SHIFT <sup>2,3</sup>	1	04-3129-06	04-3129-06	04-3129-06	04-3129-03	04-3129-03	04-3129-03
9	Removable Pilot Sleeve Assembly	1	04-3880-99	04-3880-99	04-3880-99	04-3880-99	04-3880-99	04-3880-99
10	Pilot Spool Retaining O-Ring (-009, Ø.208" x Ø.070")	2	04-2650-49-700	04-2650-49-700	04-2650-49-700	04-2650-49-700	04-2650-49-700	04-2650-49-700
11	Shaft Seal	2	08-3210-55-225	08-3210-55-225	08-3210-55-225	08-3210-55-225	08-3210-55-225	08-3210-55-225
12	Bushing, Shaft	2	08-3306-13	08-3306-13	08-3306-13	08-3306-13	08-3306-13	08-3306-13
13	Gasket, Center Block, Pro-Flo® SHIFT	2	04-3529-56	04-3529-56	04-3529-56	04-3529-56	04-3529-56	04-3529-56
14	O-Ring, (-210, Ø.734" x Ø.139")	2	04-3209-49	04-3209-49	04-3209-49	04-3209-49	04-3209-49	04-3209-49
15	Air Control Spool	1	04-3859-03	04-3859-03	04-3859-03	04-3859-03	04-3859-03	04-3859-03
16	Air Control Spool Retaining O-Ring (-114, Ø.612" x Ø.103")	2	04-3879-50	04-3879-50	04-3879-50	04-3879-50	04-3879-50	04-3879-50
17	Air Chamber, Pro-Flo V™	2	04-3660-06	04-3660-06	04-3660-06	04-3660-03	04-3660-03	04-3660-03
18	Screw, HSFHS, (3/8"-16 x 1")	8	71-6250-03	71-6250-03	71-6250-03	71-6250-03	71-6250-03	71-6250-03
19	Retaining Ring	2	04-3890-03	04-3890-03	04-3890-03	04-3890-03	04-3890-03	04-3890-03
20	Bushing, Reducer, 1-1/2" MNPT to 1" FNPT	1	04-6959-03	04-6959-03	04-6959-03	04-6959-03	04-6959-03	04-6959-03
21	Muffler, 1" MNPT	1	15-3510-06R	15-3510-06R	15-3510-06R	15-3510-06R	15-3510-06R	15-3510-06R
22	Grounding Screw, (10-32 x 1/2") Self Tapping	1	04-6345-08	04-6345-08	04-6345-08	04-6345-08	04-6345-08	04-6345-08
23	Plug, 1/4" SHCS (3-A)	4	N/A	N/A	N/A	N/A	N/A	02-7825-17
	Plug, 1/4" SHCS (3-A)	6	N/A	N/A	02-7825-17	N/A	N/A	N/A
<b>WETTED PATH COMPONENTS</b>								
▲ 24	Chamber, Liquid CIP 1-1/2" EHEDG	2	04-5000-10-385P	04-5000-10-385P	04-5000-10-385P	04-5000-10-385P	04-5000-10-385P	04-5000-10-385P
25	Clamp Band Assy, 2-1/2"	8	04-7104-03	04-7104-03	04-7104-03	04-7104-03	04-7104-03	04-7104-03
▲ 26	Elbow, 1-1/2" EHEDG	4	04-5240-10-385P	04-5240-10-385P	04-5240-10-385P	04-5240-10-385P	04-5240-10-385P	04-5240-10-385P
▲ 27	T-Section, 1-1/2" EHEDG	2	04-5160-10-385P	04-5160-10-385P	04-5160-10-385P	04-5160-10-385P	04-5160-10-385P	04-5160-10-385P
	T-Section, 1-1/2" EHEDG DIN	2	04-5160-10-386P	04-5160-10-386P	N/A	04-5160-10-386P	04-5160-10-386P	N/A
	T-Section, 1-1/2" EHEDG SMS	2	04-5160-10-387P	04-5160-10-387P	N/A	04-5160-10-387P	04-5160-10-387P	N/A
28	Clamp Band, Assy, Small	4	02-7100-03-85	02-7100-03-85	02-7100-03-85	02-7100-03-85	02-7100-03-85	02-7100-03-85
29	Clamp Band Assy, 2 Large	2	04-7330-03-385	04-7330-03-385	04-7330-03-385	04-7330-03-385	04-7330-03-385	04-7330-03-385
30	Bolt, RHSN, 5/16"-18 X 2 1/2"	4	04-6070-03	04-6070-03	04-6070-03	04-6070-03	04-6070-03	04-6070-03
31	Washer, (Ø.343 X Ø.750 X .05)	4	01-6732-03	01-6732-03	01-6732-03	01-6732-03	01-6732-03	01-6732-03
32	Wing Nut, Medium Clamp	4	08-6661-10	08-6661-10	08-6661-10	08-6661-10	08-6661-10	08-6661-10
<b>GASKETS/VALVE BALLS/MUSHROOM VALVE</b>								
▲ 33	Gasket, 1-1/2", PKG 4	1	*	*	*	*	*	*
▲ 34	Gasket, 2-1/2", PKG 8	1	*	*	*	*	*	*
▲ 35	Valve Ball, PKG 4	1	*	*	*	*	*	*
▲ 36	Mushroom Valve, PKG 4	1	04-1096-55E	N/A	N/A	04-1096-55E	N/A	N/A
<b>CHECK VALVE COMPONENTS</b>								
▲ 37	Ball Cage, 1-1/2" EHEDG	4	04-5350-10-385P	04-5350-10-385P	04-5350-10-385P	04-5350-10-385P	04-5350-10-385P	04-5350-10-385P
▲ 38	Mushroom Valve Housing	4	04-5431-10-385P	N/A	N/A	04-5431-10-385P	N/A	N/A
<b>FULL-STROKE RUBBER/TPE/PTFE/FSIPD COMPONENTS</b>								
39	Shaft, Pro-Flo™, Non-PTFE	1	04-3800-03-700	04-3800-03-700	04-3800-03-700	04-3800-03-700	04-3800-03-700	04-3800-03-700
40	Shaft Stud, 1/2"-20 X 1-7/8"	2	08-6150-08	08-6150-08	08-6150-08	08-6150-08	08-6150-08	08-6150-08
41	Piston, Inner, P4 (Non-PTFE)	2	04-3700-01-700	04-3700-01-700	04-3700-01-700	04-3700-01-700	04-3700-01-700	04-3700-01-700
42	Diaphragm, Full-Stroke PTFE, Backup, PKG 2	1	*	N/A	N/A	*	N/A	N/A
	Diaphragm, Full-Stroke IPD, Backup (3-A), PKG 2	1	N/A	N/A	04-1061-55E	N/A	N/A	04-1061-55E
▲ 43	Diaphragm, Primary, PKG 2	1	*	N/A	N/A	*	N/A	N/A
	Diaphragm, Full-Stroke PTFE, Primary, PKG 2	1	04-1040-55E	N/A	N/A	04-1040-55E	N/A	N/A
	Diaphragm, Full-Stroke IPD, Primary, PKG 2	1	N/A	04-1031-57E	04-1031-57E	N/A	04-1031-57E	04-1031-57E
▲ 44	Piston, Outer, (Non-PTFE)	2	04-4550-10-385P	N/A	N/A	04-4550-10-385P	N/A	N/A

\*Refer to Elastomer Chart.

▲ Product Contact Components.

<sup>1</sup>Includes: items 2 and 3.

<sup>2</sup>Includes: items 11, 12 and 14.

<sup>3</sup>Includes: items 46 and 47.

<sup>4</sup>Includes: items 46, 51, 52, 53 and 54.

All boldface items are primary wear parts.

LW0246 Rev. D



**EXPLODED VIEW & PARTS LISTING (CON'T)**

**PS4 SANIFLO™ HS**

**1935/2004/EC**

**PARTS LISTING**

Item	Description	QTY	NICKEL PLATED ADS			STAINLESS STEEL ADS		
			PS4 HS P/N	PS4 HS EHEDG P/N	PS4 HS 3-A P/N	PS4 HS P/N	PS4 HS EHEDG P/N	PS4 HS 3-A P/N
<b>REDUCED-STROKE IPD COMPONENTS</b>								
39	Shaft, Pro-Flo™	1	04-3820-03-700	04-3820-03-700	04-3820-03-700	04-3820-03-700	04-3820-03-700	04-3820-03-700
40	Shaft Stud, 1/2"-20 X 1-7/8"	2	08-6150-08	08-6150-08	08-6150-08	08-6150-08	08-6150-08	08-6150-08
41	Piston, Inner, 1-1/2" EHEDG	2	04-3755-01	04-3755-01	04-3755-01	04-3755-01	04-3755-01	04-3755-01
<b>42</b>	<b>Diaphragm, Backup, IPD (3-A), PKG 2</b>	<b>1</b>	<b>N/A</b>	<b>N/A</b>	<b>04-1060-55E</b>	<b>N/A</b>	<b>N/A</b>	<b>04-1060-55E</b>
<b>▲ 43</b>	<b>Diaphragm, Integral Piston, PKG 2</b>	<b>1</b>	<b>04-1030-72E</b>	<b>04-1030-72E</b>	<b>04-1030-72E</b>	<b>04-1030-72E</b>	<b>04-1030-72E</b>	<b>04-1030-72E</b>
<b>FIXED-STAND COMPONENTS</b>								
45	Stand, Pump, PV Assy. <sup>3</sup>	1	04-7654-03	04-7654-03	N/A	04-7654-03	04-7654-03	N/A
46	Nut, Cap, 5/16"-18, Pump Stand	4	08-6600-03-72	08-6600-03-72	08-6600-03-72	08-6600-03-72	08-6600-03-72	08-6600-03-72
47	Pad, Pump Stand	4	08-7670-20	08-7670-20	N/A	08-7670-20	08-7670-20	N/A
48	Washer, Flat (Ø.406 X Ø.812 X .065)	2	04-6740-03	04-6740-03	N/A	04-6740-03	04-6740-03	N/A
49	Screw, HHC, 3/8"-16 X 1-1/4"	2	04-6190-03	04-6190-03	04-6190-03	04-6190-03	04-6190-03	04-6190-03
<b>SWIVEL-STAND COMPONENTS</b>								
50	Pump Stand, Swivel, Assy. <sup>4</sup> (3-A)	1	04-7655-03	04-7655-03	04-7655-03	04-7655-03	04-7655-03	04-7655-03
51	Bushing, Center Block Mounting	1	15-7667-03	15-7667-03	15-7667-03	15-7667-03	15-7667-03	15-7667-03
52	Locking Pin	1	08-7694-03	08-7694-03	08-7694-03	08-7694-03	08-7694-03	08-7694-03
53	Screw, HHC, 1/2"-13 X 6"	1	15-6143-03	15-6143-03	15-6143-03	15-6143-03	15-6143-03	15-6143-03
49	Screw, HHC, 3/8"-16 X 1-1/4"	2	04-6190-03	04-6190-03	04-6190-03	04-6190-03	04-6190-03	04-6190-03
46	Nut, Cap, 5/16"-18, Pump Stand	4	08-6600-03-72	08-6600-03-72	08-6600-03-72	08-6600-03-72	08-6600-03-72	08-6600-03-72
54	Pad, Pump Stand 2" (3-A)	4	08-7672-20	08-7672-20	08-7672-20	08-7672-20	08-7672-20	08-7672-20
<b>ACCESSORY COMPONENTS</b>								
55	Control Module, Wil-Gard III, (3-A)	1	65-8015-99	65-8015-99	65-8015-99	65-8015-99	65-8015-99	65-8015-99
56	Sensor Cables, Wil-Gard II (3-A)	1	65-8020-99	65-8020-99	65-8020-99	65-8020-99	65-8020-99	65-8020-99

LW0246 Rev. D

\*Refer to Elastomer Chart.

▲ Product Contact Components.

<sup>1</sup>Includes: items 2 and 3.

<sup>2</sup>Includes: items 11, 12 and 14.

<sup>3</sup>Includes: items 46 and 47.

<sup>4</sup>Includes: items 46, 51, 52, 53 and 54.

**All boldface items are primary wear parts.**



## ELASTOMER OPTIONS

## ▲ PS4 SANIFLO™ HS

MATERIAL	DIAPHRAGMS (Color Code)	FULL-STROKE DIAPHRAGMS (Color Code)	FULL-STROKE BACKUP DIAPHRAGMS (Color Code)	EZ-INSTALL DIAPHRAGMS (Color Code)	FULL-STROKE IPD DIAPHRAGMS (Color Code)	FULL-STROKE IPD BACKUP DIAPHRAGMS (Color Code)	VALVE BALLS (Color Code)	GASKETS, 1½" (Color Code)	GASKETS, 2½" (Color Code)
FDA BUNA-N	04-1010-69 (2 yellow dots)	N/A	N/A	N/A	N/A	N/A	04-1080-69 (2 yellow dots)	04-1375-69 (red dot)	04-1215-69 (red dot)
FDA EPDM	04-1010-74 (2 blue dots)	N/A	N/A	N/A	N/A	N/A	04-1080-74 (2 blue dots)	04-1375-74 (green dot)	04-1215-74 (green dot)
SANIFLEX™	04-1010-56 (cream)	N/A	04-1065-56 (cream)	04-1022-56 (cream)	N/A	N/A	04-1080-56 (cream)	N/A	N/A
PTFE	04-1030-72 (2 blue dots)	04-1040-55 (white)	N/A	N/A	N/A	04-1061-55 (white)	04-1080-55 (white)	04-1375-55 (white)	04-1215-55 (white)
FDA WIL-FLEX™	N/A	N/A	04-1065-57 (2 orange dots)	04-1022-57 (2 orange dots)	04-1031-57 (2 orange dots)	N/A	04-1080-57 (2 orange dots)	N/A	N/A
FDA VITON®	N/A	N/A	N/A	N/A	N/A	N/A	N/A	04-1375-68 (white/yellow)	04-1215-68 (white/yellow)

\*\* See BOM Chart

LW0245 Rev. D

▲ Product Contact Components

## ▲ PS4 SANIFLO™ HS 1935/2004/EC

MATERIAL	DIAPHRAGMS (Color Code)	FULL-STROKE DIAPHRAGMS (Color Code)	FULL-STROKE BACKUP DIAPHRAGMS (Color Code)	EZ-INSTALL DIAPHRAGMS (Color Code)	FULL-STROKE IPD DIAPHRAGMS (Color Code)	FULL-STROKE IPD BACKUP DIAPHRAGMS (Color Code)	VALVE BALLS (Color Code)	GASKETS, 1½" (Color Code)	GASKETS, 2½" (Color Code)
FDA BUNA-N	04-1010-69E (2 yellow dots)	N/A	N/A	N/A	N/A	N/A	04-1080-69E (2 yellow dots)	04-1375-69E (red dot)	04-1215-69E (red dot)
FDA EPDM	04-1010-74E (2 blue dots)	N/A	N/A	N/A	N/A	N/A	04-1080-74E (2 blue dots)	04-1375-74E (green dot)	04-1215-74E (green dot)
SANIFLEX™	04-1010-56E (cream)	N/A	04-1065-56E (cream)	04-1022-56E (cream)	N/A	N/A	04-1080-56E (cream)	N/A	N/A
PTFE	04-1030-72E (2 blue dots)	04-1040-55E (white)	N/A	N/A	N/A	04-1061-55E (white)	04-1080-55E (white)	04-1375-55E (white)	04-1215-55E (white)
FDA WIL-FLEX™	N/A	N/A	04-1065-57E (2 orange dots)	04-1022-57E (2 orange dots)	04-1031-57E (2 orange dots)	N/A	04-1080-57E (2 orange dots)	N/A	N/A
FDA VITON®	N/A	N/A	N/A	N/A	N/A	N/A	N/A	04-1375-68E (white/yellow)	04-1215-68E (white/yellow)

\*\* See BOM Chart

LW0246 Rev. D

▲ Product Contact Components

ISSUE DATE: June 22, 1995

CERTIFICATE AUTHORIZATION NUMBER: 833



THIS IS TO CERTIFY THAT

Wilden Pump &amp; Engineering LLC

22069 Van Buren Street, Grand Terrace, CA 92313-5651

is hereby authorized to continue to apply the  
3-A Symbol to the models of equipment, conforming to 3-A Sanitary Standards for:

Number 44-03  
44-03 (Diaphragm Pumps)

set forth below

CIP Models: PX, XPX, PS, XPS, Sizes: 02, 04, 08, 15; Wetted Housing: SZ; Center / Air Valve: NNN,  
SSS; Diaphragms: LEL, FWL; Check Balls: FB, FE, FS, FW, TF; Gaskets: FB, FE, FV, TF; Leak  
Detection: 0774, 0775.

VALID THROUGH: **December 31, 2017**

Timothy R. Rugh  
Executive Director  
3-A Sanitary Standards, Inc.

The issuance of this process certificate for the listed Accepted Practices is based upon the voluntary certification, by the applicant for it, that the equipment listed above conforms fully with the 3-A Accepted Practice(s) designated. Legal responsibility for conformance is solely that of the holder of this Process Certificate, and 3-A Sanitary Standards, Inc. does not warrant that the holder of a certificate at all times conforms with the provisions of the said 3-A Accepted Practice(s). This in no way affects the responsibility of 3-A Sanitary Standards, Inc. to take appropriate action in such cases in which evidence of nonconformance had been established.

NEXT TPV INSPECTION/REPORT DUE: **March 2020**



CERTIFICATE OF COMPLIANCE



TNO Certification hereby declares that the product

Air operated double Diaphragm Pump type Saniflo HS size 1.0" to 3.0"

From

Wilden Pump & Engineering, LLC, Grand Terrace, USA

has been evaluated for compliance with the Hygienic Equipment Design Criteria of the EHEDG, Document No. 8, by:

TNO Quality of Life at Zeist, Netherlands and meets the criteria of this document as demonstrated by:

Evaluation Report No. V6621RE

Signed [Signature]  
Evaluation Officer

Date June 15, 2006

Signed [Signature]  
Managing Director, TNO Certification

Date June 15, 2006



Certificate No. C06-8337

# WILDEN®

## DECLARATION OF COMPLIANCE

STATEMENT OF COMPLIANCE TO REGULATIONS (EC) No 1935/2004  
 ON MATERIALS AND ARTICLES INTENDED TO COME INTO CONTACT WITH FOOD  
 (as per Article 16 of REGULATION (EC) No 1935/2004)



**Wilden® Pump & Engineering, LLC**, 22069 Van Buren Street, Grand Terrace, CA 92313-5607 USA, declares the equipment listed below intended to come into contact with food comply with the requirements of Regulation (EC) No 1935/2004 of 27<sup>th</sup> October 2004 and (EC) No 2023/2006 of 22<sup>nd</sup> December 2006.

- **Saniflo™ HS Models:**  
 (PX,XPX)(2,4,8,15)/(SS,SZ)(SSS,NNN)/(BNU,EPU,FBS,FES,FSS,FWL,FWS,LEL,TEU,TSS,TSU,TWS,ZSS)/  
 (FB,FE,FS,FV,FW,SF,TF,TM)/(FB,FE,FV,TF)/(0770-0789)E
- **13 mm (½") FDA Pro-Flo® & Pro-Flo X™ Models:**  
 (P,PX,XPX)1/(SS,SZ)(AAA,GGG,JJJ,LLL,PPP)/(FSS,TEU,TSU)/(FS,TF)/S(FS,TF)/(0067,0070,0120)E
- **25 mm (1") FDA Pro-Flo® Models:**  
 P2/(SS,SZ)(LLL,PPP)/(FBS,FES,FSS,FWL,FWS,LEL,TEU,TSS,TSU,TWS)/(FS,TF)/S(FS,TF)/2070E
- **38 mm (1-½") FDA Pro-Flo® & Pro-Flo X™ Models:**  
 (P,PX,XPX)4/(SS,SZ)(A,C,L,N,S,V)(AA,LL,NN,PP,SS)/(BNU,EPU,FBS,FES,FSS,FWL,FWS,LEL,TEU,TSS,TSU,TWS,ZSS)/  
 (FB,FE,FS,FV,FW,TF,)/(FS,FW,STF)/(0067,0070,0075,0120)E
- **51 mm (2") FDA Pro-Flo® & Pro-Flo X™ Models:**  
 (P,PX,XPX)8/SS(A,C,N,S,V)(AA,NN,PP,SS)/(BNU,EPU,FBS,FES,FSS,FWS,FWL,TEU,TSU,TSS,TWS,ZSS)/(FS,FW,TF)/  
 (FS,FW,STF)/(0070,0075,0120)E
- **76 mm (3") FDA Pro-Flo X™ Models:**  
 (PX,XPX)15/SS(A,C,N,S)(AA,SS,PP)/(BNU,EPU,FSS,FWL,FWS,TEU,TSU,TSS,TWS,ZSS)/(FS,FW,TF)/(FS,FW,STF)/  
 (0070,0075,0120,0341)E
- **38 mm (1-½") FDA Pro-Flo® SHIFT Models:**  
 XPS4/(SS,SZ)(AAA,NNN)/(FBS,FES,FWL,FWS,TSS,TWS,ZSS)/(FS,FW,TF)/(FS,FW,STF)/(0067,0070, 0075, 0120)E
- **51 mm (2") FDA Pro-Flo® SHIFT Models:**  
 XPS8/(SS,SZ)(AAA,NNN)/(FBS,FES,FWL,FWS,TSS,TWS,ZSS)/(FS,FW,TF)/(FS,FW,STF)/(0070,0075,0120)E
- **76 mm (3") FDA Pro-Flo® SHIFT Models:**  
 XPS15/(SS,SZ)(AAA,NNN)/(FWL,FWS,TSS,TWS,ZSS)/(FS,FW,TF)/(FS,FW,STF)/(0070,0120,0341)E

Materials used in the equipment that are intended to contact food belong to the groups of materials listed in Annex 1 (EC) 1935/2004.  
 (List of groups of materials and articles that may be covered by specific measures)

- 5) Rubbers       8) Metal and Alloy       10) Plastics

Compliance is subject to material and equipment storage, handling and usage recommended by **Wilden®** in the engineering operation and maintenance manual and supplemental technical publications.

This declaration is based on the following information:  
 Statements of raw material suppliers

**Wilden®** will make available to the competent authorities appropriate documentation to demonstrate compliance.

Approved By:

Chris Distaso  
 Director of Engineering  
 Date: March 17, 2015



**NOTES**

**NOTES**

**WARRANTY**

Each and every product manufactured by Wilden Pump and Engineering, LLC is built to meet the highest standards of quality. Every pump is functionally tested to insure integrity of operation.

Wilden Pump and Engineering, LLC warrants that pumps, accessories and parts manufactured or supplied by it to be free from defects in material and workmanship for a period of five (5) years from date of installation or six (6) years from date of manufacture, whichever comes first. Failure due to normal wear, misapplication, or abuse is, of course, excluded from this warranty.

Since the use of Wilden pumps and parts is beyond our control, we cannot guarantee the suitability of any pump or part for a particular application and Wilden Pump and Engineering, LLC shall not be liable for any consequential damage or expense arising from the use or misuse of its products on any application. Responsibility is limited solely to replacement or repair of defective Wilden pumps and parts.

All decisions as to the cause of failure are the sole determination of Wilden Pump and Engineering, LLC.

Prior approval must be obtained from Wilden for return of any items for warranty consideration and must be accompanied by the appropriate MSDS for the product(s) involved. A Return Goods Tag, obtained from an authorized Wilden distributor, must be included with the items which must be shipped freight prepaid.

The foregoing warranty is exclusive and in lieu of all other warranties expressed or implied (whether written or oral) including all implied warranties of merchantability and fitness for any particular purpose. No distributor or other person is authorized to assume any liability or obligation for Wilden Pump and Engineering, LLC other than expressly provided herein.

**PLEASE PRINT OR TYPE AND FAX TO WILDEN**

<b>PUMP INFORMATION</b>			
Item # _____		Serial # _____	
Company Where Purchased _____			
<b>YOUR INFORMATION</b>			
Company Name _____			
Industry _____			
Name _____		Title _____	
Street Address _____			
City _____	State _____	Postal Code _____	Country _____
Telephone _____	Fax _____	E-mail _____	Web Address _____
Number of pumps in facility? _____		Number of Wilden pumps? _____	
Types of pumps in facility (check all that apply): <input type="checkbox"/> Diaphragm <input type="checkbox"/> Centrifugal <input type="checkbox"/> Gear <input type="checkbox"/> Submersible <input type="checkbox"/> Lobe			
<input type="checkbox"/> Other _____			
Media being pumped? _____			
How did you hear of Wilden Pump? <input type="checkbox"/> Trade Journal <input type="checkbox"/> Trade Show <input type="checkbox"/> Internet/E-mail <input type="checkbox"/> Distributor		<input type="checkbox"/> Other _____	

**ONCE COMPLETE, FAX TO (909) 783-3440**

**OR GO TO [PSGDOVER.COM](http://PSGDOVER.COM) > WILDEN > SUPPORT TO COMPLETE THE WARRANTY REGISTRATION ONLINE**

NOTE: WARRANTY VOID IF PAGE IS NOT FAXED TO WILDEN OR SUBMITTED ONLINE VIA THE [PSGDOVER.COM](http://PSGDOVER.COM) WEBSITE

WILDEN PUMP & ENGINEERING, LLC



## Where Innovation Flows



PSG reserves the right to modify the information and illustrations contained in this document without prior notice. This is a non-contractual document. 02-2017

# WILDEN®

PSG

22069 Van Buren St., Grand Terrace, CA 92313-5607

P: +1 (909) 422-1730 • F: +1 (909) 783-3440

[wildenpump.com](http://wildenpump.com)

Authorized PSG Representative:

Copyright ©2017, PSG, A Dover Company