

WILDEN®

EOM
Engineering
Operation &
Maintenance

PS Brahma
Metal Pump

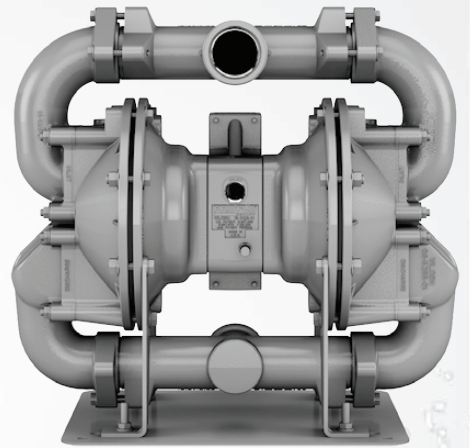

Where Innovation Flows

wildenpump.com





TABLE OF CONTENTS

SECTION 1	CAUTIONS—READ FIRST!	1
SECTION 2	WILDEN PUMP DESIGNATION SYSTEM	2
SECTION 3	HOW IT WORKS—PUMP & AIR DISTRIBUTION SYSTEM	3
SECTION 4	DIMENSIONAL DRAWING	4
SECTION 5	PERFORMANCE	
	PS Brahma Performance	
	PS810 Brahma Rubber-Fitted	5
	PS1510 Brahma Rubber-Fitted	5
	Suction-Lift Curves	6
SECTION 6	SUGGESTED INSTALLATION, OPERATION & TROUBLESHOOTING	7
SECTION 7	DISASSEMBLY / REASSEMBLY	10
	Air Valve / Center Section Disassembly	15
	Reassembly Hints & Tips	19
SECTION 8	EXPLODED VIEW & PARTS LISTING	
	PS810 Brahma Metal	21
	PS1510 Brahma Metal	23
SECTION 9	ELASTOMER OPTIONS	25



CAUTIONS—READ FIRST!

 **CAUTION:** Do not apply compressed air to the exhaust port — pump will not function.

 **CAUTION:** Do not over-lubricate air supply — excess lubrication will reduce pump performance. Pump is pre-lubed.

 **TEMPERATURE LIMITS:**

Acetal	-29°C to 82°C	-20°F to 180°F
Buna-N	-12°C to 82°C	10°F to 180°F
Geolast®	-40°C to 82°C	-40°F to 180°F
Neoprene	-18°C to 93°C	0°F to 200°F
Nordel® EPDM	-51°C to 138°C	-60°F to 280°F
Nylon	-18°C to 93°C	0°F to 200°F
PFA	-7°C to 107°C	45°F to 225°F
Polypropylene	0°C to 79°C	32°F to 175°F
Polyurethane	-12°C to 66°C	10°F to 150°F
PVDF	-12°C to 107°C	10°F to 225°F
Saniflex™	-29°C to 104°C	-20°F to 220°F
SIPD PTFE with EPDM-backed	4°C to 137°C	40°F to 280°F
SIPD PTFE with Neoprene-backed	4°C to 93°C	40°F to 200°F
PTFE ¹	4°C to 104°C	40°F to 220°F
Viton® FKM	-40°C to 177°C	-40°F to 350°F
Wil-Flex™	-40°C to 107°C	-40°F to 225°F

¹4°C to 149°C (40°F to 300°F) - 13 mm (1/2") and 25 mm (1") models only.

NOTE: Not all materials are available for all models. Refer to Section 2 for the material options available for your pump.

 **CAUTION:** When choosing pump materials, be sure to check the temperature limits for all wetted components. Example: Viton® has a maximum limit of 177°C (350°F), but polypropylene has a maximum limit of only 79°C (175°F).

 **CAUTION:** Maximum temperature limits are based upon mechanical stress only. Certain chemicals will significantly reduce maximum safe operating temperatures. Consult Chemical Resistance Guide for chemical compatibility and temperature limits.

 **WARNING:** Prevent static sparking — If static sparking occurs, fire or explosion could result. Pump, valves and containers must be grounded to a proper grounding point when handling flammable fluids and whenever discharge of static electricity is a hazard.

 **CAUTION:** Do not exceed 8.6 bar (125 psig) air supply pressure.

 **CAUTION:** The process fluid and cleaning fluids must be chemically compatible with all wetted pump components. Consult Chemical Resistance Guide.

 **CAUTION:** Do not exceed 82°C (180°F) air inlet temperature for Pro-Flo® SHIFT models.

 **CAUTION:** Pumps should be thoroughly flushed before installing into process lines. FDA- and USDA-approved pumps should be cleaned and/or sanitized before being used.

 **CAUTION:** Always wear safety glasses when operating pump. If diaphragm rupture occurs, material being pumped may be forced out air exhaust.

 **CAUTION:** Before any maintenance or repair is attempted, the compressed air line to the pump should be disconnected and all air pressure allowed to bleed from pump. Disconnect all intake, discharge and air lines. Drain the pump by allowing any fluid to flow into a suitable container.

 **CAUTION:** Blow out air line for 10 to 20 seconds before attaching to pump to make sure all pipeline debris is clear. Use an in-line air filter. A 5µ (micron) air filter is recommended.

 **NOTE:** Before starting disassembly, mark a line from each liquid chamber to its corresponding air chamber. This line will assist in proper alignment during reassembly.

 **CAUTION:** Pro-Flo® SHIFT is available in both single-point exhaust (submersible) and standard (non-submersible) options. Do not use standard Pro-Flo® SHIFT models in submersible applications.

 **CAUTION:** Tighten all hardware prior to installation.



WILDEN PUMP DESIGNATION SYSTEM

PS BRAHMA

51 mm (2") Pump
Maximum Flow Rate:
640 lpm (169 gpm)

76 mm (3") Pump
Maximum Flow Rate:
885 lpm (234 gpm)

LEGEND

XPSXXX / XXXXX / XXX / XX / XXX / XXXX

MODEL

WETTED PARTS

AIR VALVE

CENTER BLOCK

AIR CHAMBERS

DIAPHRAGMS

FLAP VALVES

VALVE SEATS

GASKETS

SPECIALTY CODE
 (if applicable)

MATERIAL CODES

MODEL

XPS810 = 51 mm (2") ADVANCED™
 TOP INLET/BOTTOM
 DISCHARGE ATEX
 XPS1510 = 76 mm (3") ADVANCED™
 TOP INLET/BOTTOM
 DISCHARGE ATEX

WETTED PARTS / OUTER PISTON

AA = ALUMINUM / ALUMINUM
 AM = ALUMINUM / MILD STEEL
 WM = DUCTILE IRON / MILD STEEL
 WW = DUCTILE IRON / DUCTILE IRON

AIR CHAMBERS

A = ALUMINUM

CENTER BLOCK

A = ALUMINUM

AIR VALVE

A = ALUMINUM
 R = ANODIZED ALUMINUM

DIAPHRAGMS

BNS = BUNA-N (Red Dot)
 NES = NEOPRENE (Green Dot)

FLAP VALVES

BF = BUNA (Red Dot)
 NF = NEOPRENE (Green Dot)

VALVE SEATS

A = ALUMINUM
 M = MILD STEEL
 W = DUCTILE IRON

GASKETS

BN = BUNA-N (Red Dot)
 NE = NEOPRENE (Green Dot)

SPECIALTY CODES

- 0320 Single-Point Exhaust
- 0323 Single-Point Exhaust, DIN Flange
- 0504 Horizontal Center-Ported, DIN Flange
- 0677 Horizontal Center-Ported, NPT Threaded
- 0678 Horizontal Center-Ported, BSPT Threaded
- 0687 Horizontal Center-Ported, NPT Threaded, Single-Point Exhaust
- 0688 Horizontal Center-Ported, BSPT Threaded, Single-Point Exhaust

NOTE: MOST ELASTOMERIC MATERIALS USE COLORED DOT FOR IDENTIFICATION.



HOW IT WORKS—PUMP

The Wilden diaphragm pump is an air-operated, positive displacement, self-priming pump. These drawings show flow pattern through the pump upon its initial stroke. It is assumed the pump has no fluid in it prior to its initial stroke.

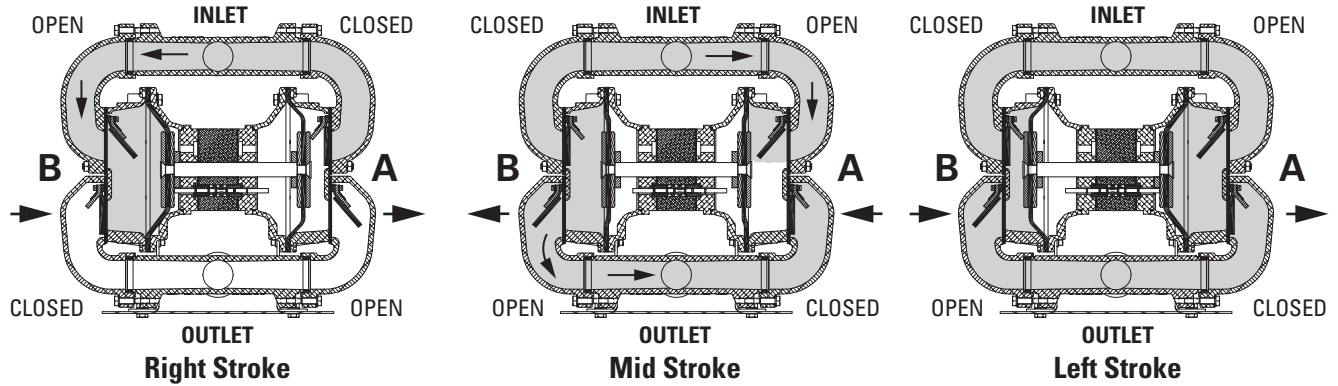

FIGURE 1 The air valve directs pressurized air to the back side of diaphragm A. The compressed air is applied directly to the liquid column separated by elastomeric diaphragms. The diaphragm acts as a separation membrane between the compressed air and liquid; a balanced load removes mechanical stress from the diaphragm. The compressed air moves the diaphragm away from the center of the pump. The opposite diaphragm is pulled in by the shaft connected to the pressurized diaphragm. Diaphragm B is on its suction stroke; air behind the diaphragm has been forced out to atmosphere through the exhaust port of the pump. The movement of diaphragm B toward the center of the pump creates a vacuum within chamber B. Atmospheric pressure forces fluid into the inlet manifold forcing the inlet check valve off its seat. Liquid is free to move past the inlet check valve and fill the liquid chamber (see shaded area).

FIGURE 2 When the pressurized diaphragm, diaphragm A, reaches the limit of its discharge stroke, the air valve redirects pressurized air to the back side of diaphragm B. The pressurized air forces diaphragm B away from the center while pulling diaphragm A to the center. Diaphragm B is now on its discharge stroke. Diaphragm B forces the inlet check valve onto its seat due to the hydraulic forces developed in the liquid chamber and manifold of the pump. These same hydraulic forces lift the discharge check valve off its seat, while the opposite discharge check valve is forced onto its seat, forcing fluid to flow through the pump discharge. The movement of diaphragm A toward the center of the pump creates a vacuum within liquid chamber A. Atmospheric pressure forces fluid into the inlet manifold of the pump. The inlet check valve is forced off its seat allowing the fluid being pumped to fill the liquid chamber.

FIGURE 3 At completion of the stroke, the air valve again redirects air to the back side of diaphragm A, which starts diaphragm B on its suction stroke. As the pump reaches its original starting point, each diaphragm has gone through one suction and one discharge stroke. This constitutes one complete pumping cycle. The pump may take several cycles to completely prime depending on the conditions of the application.

NOTE: Unlike other Wilden pumps, the fluid inlet of the Brahma Advanced™ pump is located at the top and the fluid discharge is located at the bottom of the pump.



HOW IT WORKS—AIR DISTRIBUTION SYSTEM

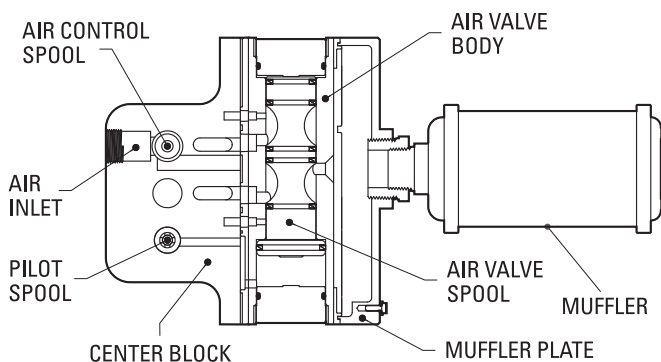

The heart of the patented Pro-Flo® SHIFT Air Distribution System (ADS) is the air valve assembly. The air valve design incorporates an unbalanced spool with the small end of the spool being pressurized continuously while the large end of the spool is alternately pressurized, then exhausted to move the spool. The air valve spool directs pressurized air to one chamber while exhausting the other. The air forces the main shaft/diaphragm assembly to move to one side – discharging liquid on that side and pulling liquid in on the other side. When the shaft reaches the end of the stroke, the inner piston actuates the pilot spool, which controls the air to the large end of the air valve spool. The repositioning of the air valve spool routes the air to the other air chamber. The air control spool allows air to flow freely into the air chamber for the majority of each pump stroke, but it significantly restricts the flow of air into the air chamber when activated by the inner piston near the end of the each stroke.



DIMENSIONAL DRAWINGS

PS810 METAL

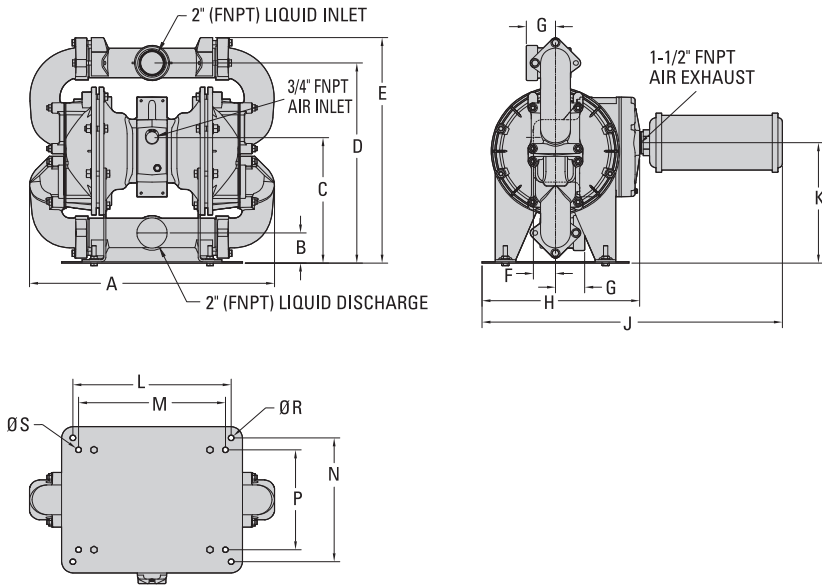

DIMENSIONS

ITEM	METRIC (mm)	STANDARD (inch)
A	550	21.7
B	68	2.7
C	283	11.1
D	451	17.8
E	509	20.0
F	50	2.0
G	66	2.6
H	354	13.9
J	680	26.7
K	272	10.7
L	356	14.0
M	330	13.0
N	279	11.0
P	226	8.9
R	13	0.5
S	13	0.5

LW0281 REV. A

PS1510 METAL

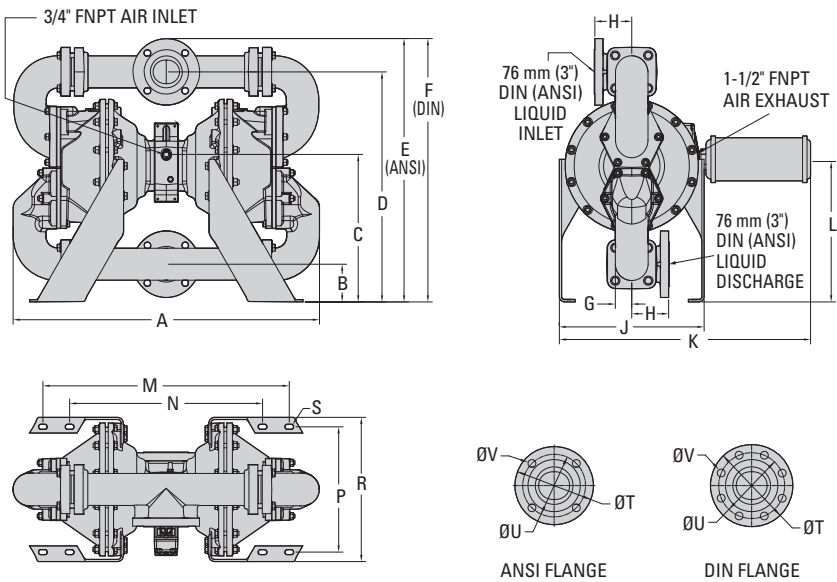

DIMENSIONS

ITEM	METRIC (mm)	STANDARD (inch)
A	874	34.4
B	107	4.2
C	422	16.6
D	658	25.9
E	754	29.7
F	757	29.8
G	46	1.8
H	104	4.1
J	411	16.2
K	716	28.2
L	401	15.8
M	704	27.7
N	551	21.7
P	358	14.1
R	411	16.2
S	8.0	0.3
	DIN (mm)	ANSI (inch)
T	200 DIA.	7.5 DIA.
U	160 DIA.	6.0 DIA.
V	18 DIA.	0.8 DIA.

LW0284 REV. B



PERFORMANCE

PS810 METAL RUBBER-FITTED

Ship Weight Aluminum 37 kg (81 lb)
 Ductile Iron 57 kg (125 lb)
 Air Inlet 19 mm (3/4")
 Inlet 51 mm (2")
 Outlet 51 mm (2")
 Suction Lift 7.4 m Dry (24.3')
 9.0 m Wet (29.5')
 Disp. per Stroke¹ 1.8 L (0.475 gal)
 Max. Flow Rate 640 lpm (169 gpm)
 Max. Size Solids 51 mm (2")

¹Displacement per stroke was calculated at 4.8 bar (70 psig) air inlet pressure against a 2.1 bar (30 psig) head pressure.

Example: To pump 303 lpm (80 gpm) against a discharge head of 2.8 bar (40 psig) requires 4.2 bar (60 psig) and 82 Nm³/h (48 scfm) air consumption.

Caution: Do not exceed 8.6 bar (125 psig) air supply pressure.

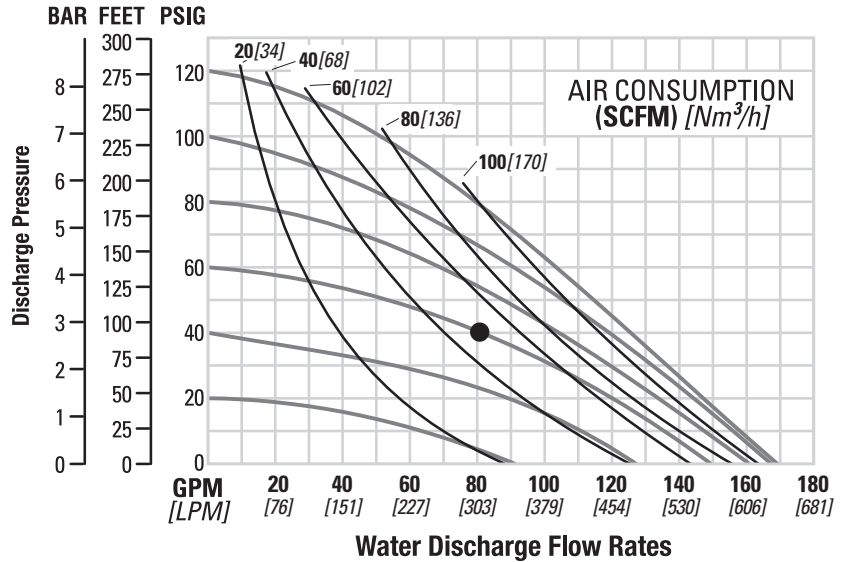

Flow rates indicated on chart were determined by pumping water.

For optimum life and performance, pumps should be specified so that daily operation parameters will fall in the center of the pump's performance curve.

PS1510 METAL RUBBER-FITTED

Ship Weight Aluminum 81 kg (179 lb)
 Ductile Iron 159 kg (350 lb)
 Air Inlet 19 mm (3/4")
 Inlet 76 mm (3")
 Outlet 76 mm (3")
 Suction Lift 7.1 m Dry (23.3')
 9.0 m Wet (29.5')
 Disp. per Stroke¹ 4.7 L (1.24 gal)
 Max. Flow Rate 882 lpm (233 gpm)
 Max. Size Solids 76 mm (3")

¹Displacement per stroke was calculated at 4.8 bar (70 psig) air inlet pressure against a 2.1 bar (30 psig) head pressure.

Example: To pump 401 lpm (106 gpm) against a discharge head of 4.2 bar (60 psig) requires 7.0 bar (100 psig) and 187 Nm³/h (110 scfm) air consumption.

Caution: Do not exceed 8.6 bar (125 psig) air supply pressure.

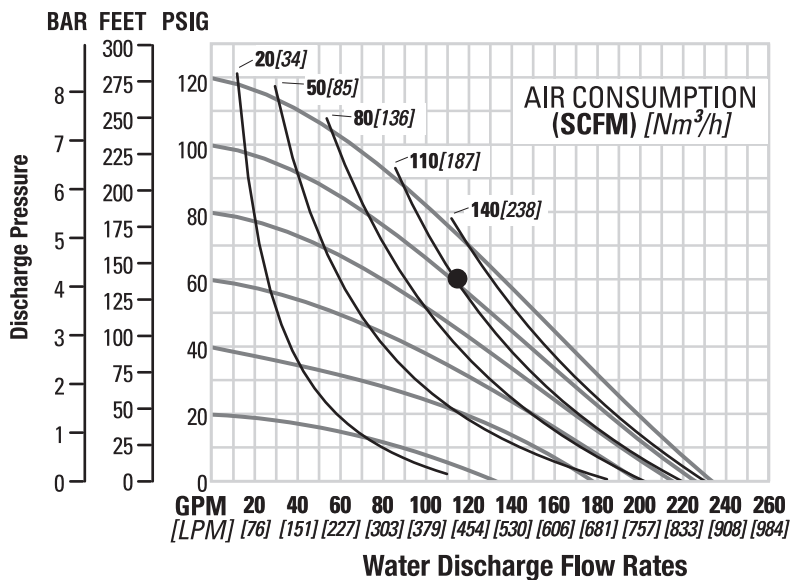

Flow rates indicated on chart were determined by pumping water.

For optimum life and performance, pumps should be specified so that daily operation parameters will fall in the center of the pump's performance curve.

SUCTION-LIFT CURVES

**PS810 METAL
SUCTION-LIFT CAPABILITY**

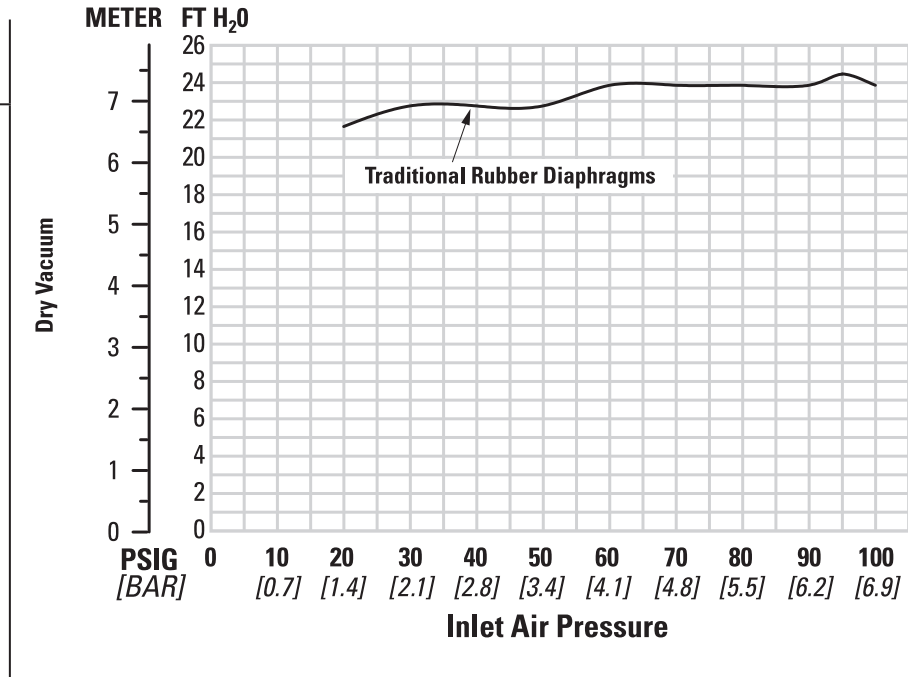

**PS1510 METAL
SUCTION-LIFT CAPABILITY**

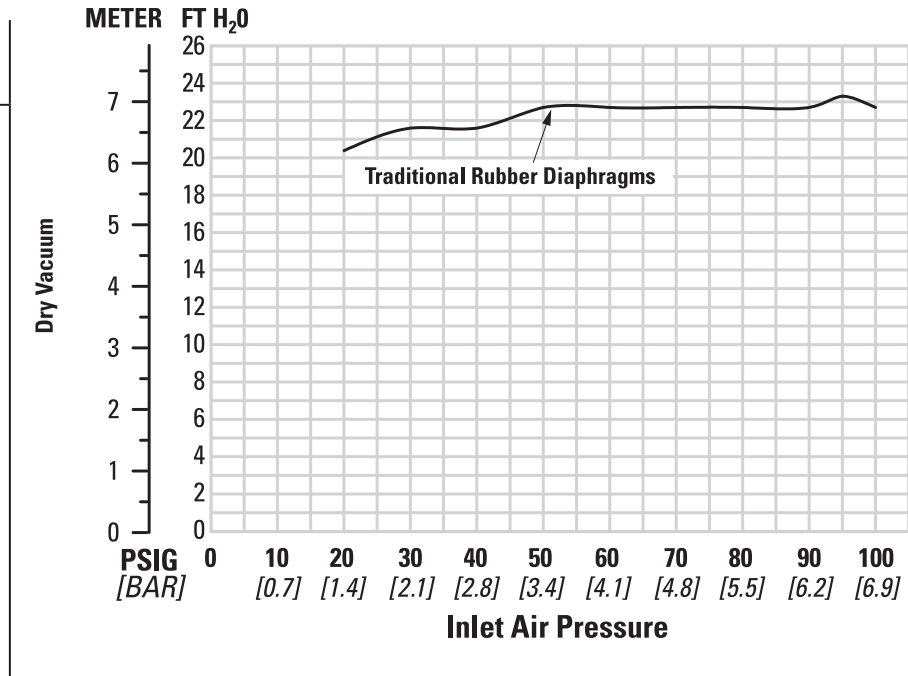

Suction-lift curves are calibrated for pumps operating at 305 m (1,000') above sea level. This chart is meant to be a guide only. There are many variables that can affect your pump's operating characteristics. The

number of intake and discharge elbows, viscosity of pumping fluid, elevation (atmospheric pressure) and pipe friction loss all affect the amount of suction lift your pump will attain.



SUGGESTED INSTALLATION

Wilden pumps are designed to meet the performance requirements of even the most demanding pumping applications. They have been designed and manufactured to the highest standards and are available in a variety of wetted-path materials to meet your chemical resistance needs. Refer to the performance section of this manual for an in-depth analysis of the performance characteristics of your pump. Wilden offers the widest variety of elastomer options in the industry to satisfy temperature, chemical compatibility, abrasion resistance and flex concerns.

The suction pipe size should be at least the equivalent or larger than the diameter size of the suction inlet on your Wilden pump. The suction hose must be non-collapsible, reinforced type as these pumps are capable of pulling a high vacuum. Discharge piping should also be the equivalent or larger than the diameter of the pump discharge which will help reduce friction losses. It is critical that all fittings and connections are airtight or a reduction or loss of pump suction capability will result.

INSTALLATION: Months of careful planning, study and selection efforts can result in unsatisfactory pump performance if installation details are left to chance.

Premature failure and long-term dissatisfaction can be avoided if reasonable care is exercised throughout the installation process.

LOCATION: Noise, safety and other logistical factors usually dictate where equipment will be situated on the production floor. Multiple installations with conflicting requirements can result in congestion of utility areas, leaving few choices for additional pumps.

Within the framework of these and other existing conditions, every pump should be located in such a way that six key factors are balanced against each other to maximum advantage.

ACCESS: First of all, the location should be accessible. If it is easy to reach the pump, maintenance personnel will have an easier time carrying out routine inspections and adjustments. Should major repairs become necessary, ease of access can play a key role in speeding the repair process and reducing total downtime.

AIR SUPPLY: Every pump location should have an air line large enough to supply the volume of air necessary to achieve the desired pumping rate. Use air pressure up to a maximum of 8.6 bar (125 psig) depending on pumping requirements.

For best results, the pumps should use a 5µ (micron) air filter, needle valve and regulator. The use of an air filter before the pump will ensure that the majority of any pipeline contaminants will be eliminated.

SOLENOID OPERATION: When operation is controlled by a solenoid valve in the air line, three-way valves should be used. This valve allows trapped air between the valve and the pump to bleed off which improves pump performance. Pumping volume can be estimated by counting the number of strokes per minute and then multiplying the figure by the displacement per stroke.

MUFFLER: Sound levels are reduced below OSHA specifications using the standard Wilden muffler. Other mufflers can be used to further reduce sound levels, but they usually reduce pump performance.

ELEVATION: Selecting a site that is well within the pump's dynamic-lift capability will ensure that loss-of-prime issues will be eliminated. In addition, pump efficiency can be adversely affected if proper attention is not given to site location.

PIPING: Final determination of the pump site should not be made until the piping challenges of each possible location have been evaluated. The impact of current and future installations should be considered ahead of time to make sure that inadvertent restrictions are not created for any remaining sites.

The best choice possible will be a site involving the shortest and straightest hookup of suction and discharge piping. Unnecessary elbows, bends, and fittings should be avoided. Pipe sizes should be selected to keep friction losses within practical limits. All piping should be supported independently of the pump. In addition, the piping should be aligned to avoid placing stress on the pump fittings.

Flexible hose can be installed to aid in absorbing the forces created by the natural reciprocating action of the pump. If the pump is to be bolted down to a solid location, a mounting pad placed between the pump and the foundation will assist in minimizing pump vibration. Flexible connections between the pump and rigid piping will also assist in minimizing pump vibration. If quick-closing valves are installed at any point in the discharge system, or if pulsation within a system becomes a problem, a surge suppressor (SD Equalizer®) should be installed to protect the pump, piping and gauges from surges and water hammer.

If the pump is to be used in a self-priming application, make sure that all connections are airtight and that the suction lift is within the model's ability. **NOTE:** Materials of construction and elastomer options have an effect on suction lift parameters. Please refer to the performance section for specifics.

When pumps are installed in applications involving flooded suction or suction head pressures, a gate valve should be installed in the suction line to permit closing of the line for pump service.

Pumps in service with a positive suction head are most efficient when inlet pressure is limited to 0.5–0.7 bar (7–10 psig). Premature diaphragm failure may occur if positive suction is 0.7 bar (10 psig) and higher.

SUBMERSIBLE APPLICATIONS: Pro-Flo® SHIFT pumps can be used for submersible applications when using the Pro-Flo® SHIFT's single-point exhaust option.

ALL WILDEN PUMPS ARE CAPABLE OF PASSING SOLIDS. A STRAINER SHOULD BE USED ON THE PUMP INTAKE TO ENSURE THAT THE PUMP'S RATED SOLIDS CAPACITY IS NOT EXCEEDED.

CAUTION: DO NOT EXCEED 8.6 BAR (125 PSIG) AIR SUPPLY PRESSURE [3.4 BAR (50 PSIG) FOR UL-LISTED MODELS.

SUGGESTED INSTALLATION

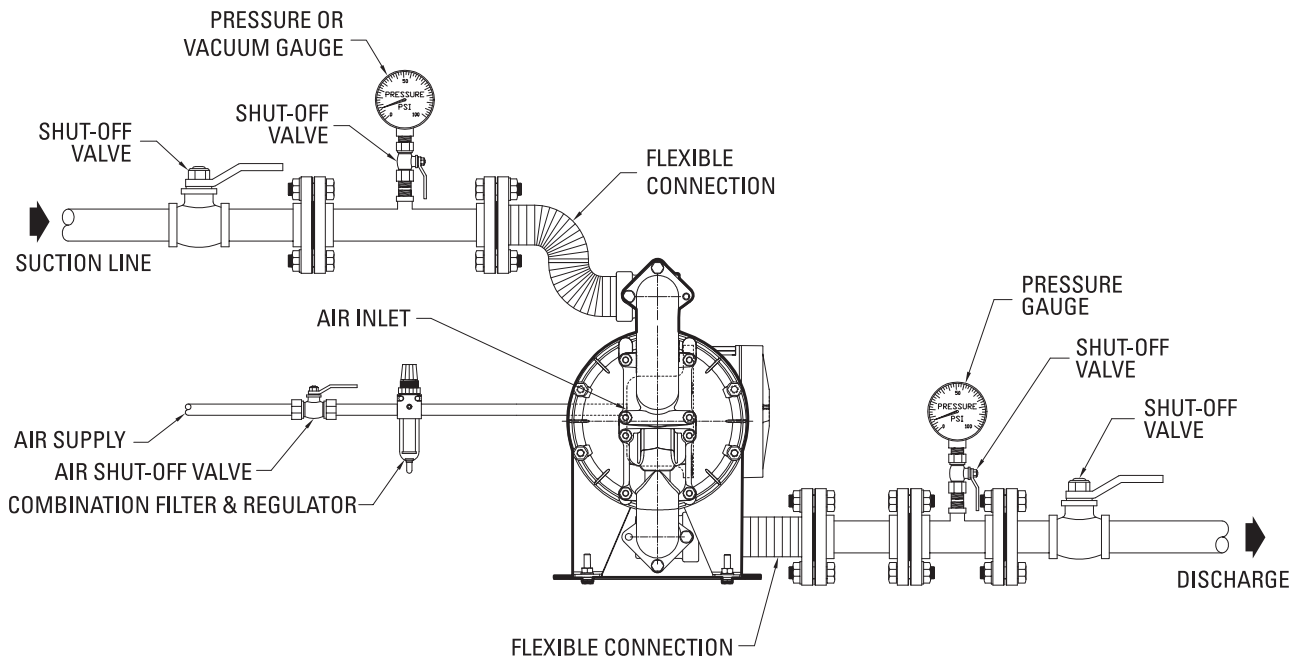

NOTE: In the event of a power failure, the shut-off valve should be closed, if restarting of the pump is not desirable once power is regained.

NOTE: The fluid inlet to the PS Brahma pump is located at the top and the fluid discharge is located at the bottom of the pump.

AIR-OPERATED PUMPS: To stop the pump from operating in an emergency situation, simply close the shut-off valve (user-supplied) installed in the air supply line. A properly functioning valve will stop the air supply to the pump, therefore stopping output. This shut-off valve should be located far enough away from the pumping equipment such that it can be reached safely in an emergency situation.

SUGGESTED OPERATION & MAINTENANCE

OPERATION: The PS Brahma is pre-lubricated, and does not require in-line lubrication. Additional lubrication will not damage the pump, however if the pump is heavily lubricated by an external source, the pump's internal lubrication may be washed away. If the pump is then moved to a non-lubricated location, it may need to be disassembled and re-lubricated as described in the DISASSEMBLY/REASSEMBLY INSTRUCTIONS.

Pump-discharge rate can be controlled by limiting the volume and/or pressure of the air supply to the pump. An air regulator is used to regulate air pressure. A needle valve is used to regulate volume. Pump-discharge rate can also be controlled by throttling the pump-discharge by partially closing a valve in the discharge line of the pump. This action increases friction loss which reduces flow rate. (See Section 5.) This is useful when the need exists to control the pump from a remote location. When the pump discharge pressure equals or exceeds the air supply pressure, the pump will stop; no bypass or pressure relief valve is needed, and pump damage will not occur. The pump has reached a "deadhead" situation and can

be restarted by reducing the fluid discharge pressure or increasing the air inlet pressure. The Wilden Pro-Flo® SHIFT pumps run solely on compressed air and do not generate heat, therefore your process fluid temperature will not be affected.

MAINTENANCE AND INSPECTIONS: Since each application is unique, maintenance schedules may be different for every pump. Frequency of use, line pressure, viscosity and abrasiveness of process fluid all affect the parts life of a Wilden pump. Periodic inspections have been found to offer the best means for preventing unscheduled pump downtime. Personnel familiar with the pump's construction and service should be informed of any abnormalities that are detected during operation.

RECORDS: When service is required, a record should be made of all necessary repairs and replacements. Over a period of time, such records can become a valuable tool for predicting and preventing future maintenance problems and unscheduled downtime. In addition, accurate records make it possible to identify pumps that are poorly suited to their applications.

TROUBLESHOOTING

Pump will not run or runs slowly.

1. Ensure that the air inlet pressure is at least 0.4 bar (5 psig) above startup pressure and that the differential pressure (the difference between air inlet and liquid discharge pressures) is not less than 0.7 bar (10 psig).
2. Check air inlet filter for debris (see SUGGESTED INSTALLATION).
3. Check for extreme air leakage (blow by) that would indicate worn seals/bores in the air valve, pilot spool and main shaft.
4. Disassemble pump and check for obstructions in the air passageways or objects that would obstruct the movement of internal parts.
5. Check mating surfaces of flap valve assembly.
6. Check for sticking check valves. If material being pumped is not compatible with pump elastomers, swelling may occur. Replace check valves with proper elastomers.
7. Check for broken inner piston that would cause the air valve spool to be unable to shift.
8. Remove plug from pilot spool exhaust.

Pump runs, but little or no product flows.

1. Check for pump cavitation; decrease pump speed to allow thick material to flow into liquid chambers.

2. Verify that vacuum required to lift liquid is not greater than the vapor pressure of the material being pumped (cavitation).
3. Check for sticking check valves. If material being pumped is not compatible with pump elastomers, swelling may occur. Replace check valves with proper elastomers.

Pump air valve freezes.

1. Check for excessive moisture in compressed air. Either install a dryer or hot-air generator for compressed air. Alternatively, a coalescing filter may be used to remove the water from the compressed air in some applications.

Air bubbles in pump discharge.

1. Check for ruptured diaphragm.
2. Check tightness of outer pistons (refer to Section 7).
3. Check tightness of fasteners and integrity of O-rings and seals, especially at intake manifold.
4. Ensure pipe connections are airtight.

Product comes out air exhaust.

1. Check for diaphragm rupture.
2. Check tightness of outer pistons to shaft.



PUMP DISASSEMBLY

TOOLS REQUIRED:

- 7/32" Hex-Head Wrench
- 3/8" Hex-Head Wrench
- 7/16" Wrench
- 9/16" Wrench
- 5/8" Wrench

CAUTION: Before any maintenance or repair is attempted, the compressed air line to the pump should be disconnected and all air pressure allowed to bleed from the pump. Disconnect all intake, discharge and air lines. Drain the pump by turning it upside down and allowing any fluid to flow into a suitable container. Be aware of any hazardous effects of contact with your process fluid.

NOTE: Your specific pump model may vary from the configuration shown; however, pump disassembly procedure will be the same.

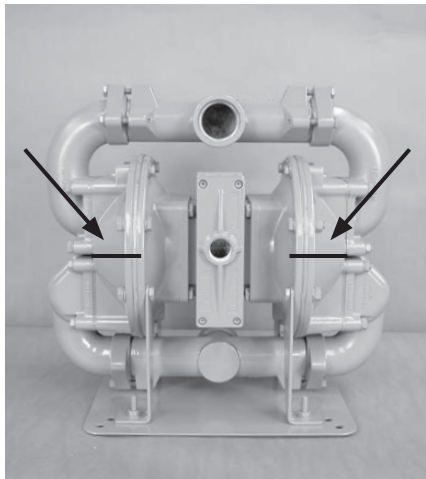
**Step 1**

Before starting disassembly, mark a line from each liquid chamber to the corresponding air chamber. This will assist in proper alignment during reassembly.

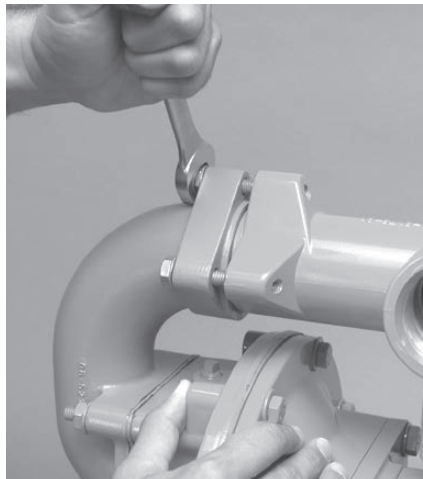
**Step 2**

Using a 9/16" wrench, remove the fasteners that connect the inlet elbow to the inlet T-section.

**Step 3**

Using a 9/16" wrench, remove the fastener that connects the elbow to the liquid chamber.

PUMP DISASSEMBLY

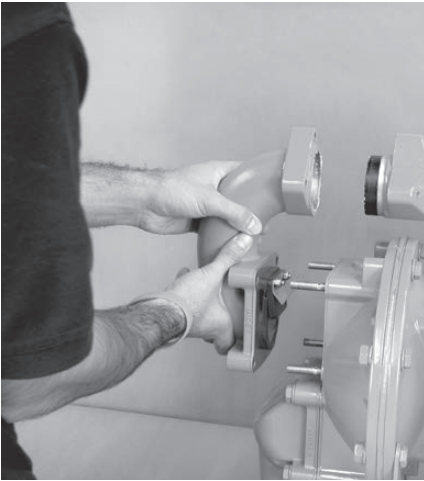

Step 4

Next, remove the inlet elbow from the liquid chamber

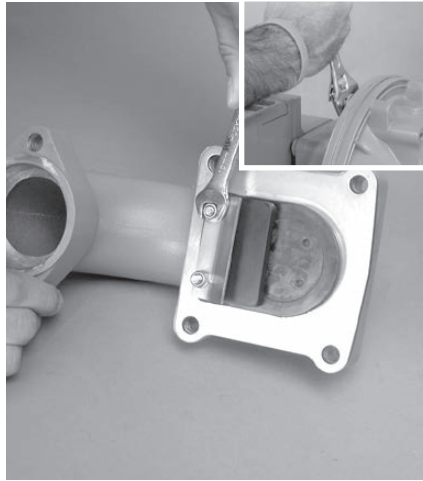

Step 5

Using a 7/16" wrench, remove the flap valve assembly from the inlet elbow. Inspect flap valves for nicks, gouges, chemical attack or abrasive wear. **NOTE:** Replace worn parts with genuine Wilden parts for reliable performance.



Step 6

Inspect manifold gasket, flap valve seat and seat gasket for nicks, gouges, chemical attack or abrasive wear.

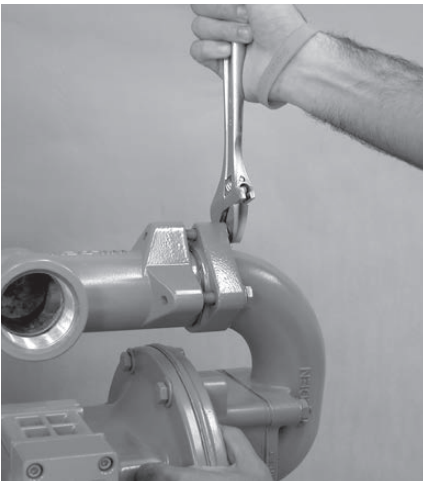

Step 7

Using a 9/16" wrench, remove the fasteners that connect the remaining inlet elbow to the inlet T-section.

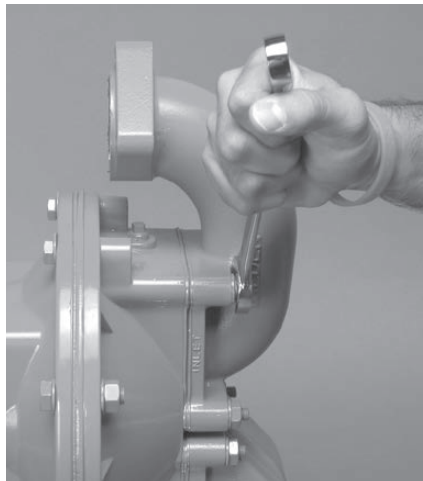

Step 8

Using a 9/16" wrench, remove the fasteners that connect the remaining inlet elbow to the liquid chamber.

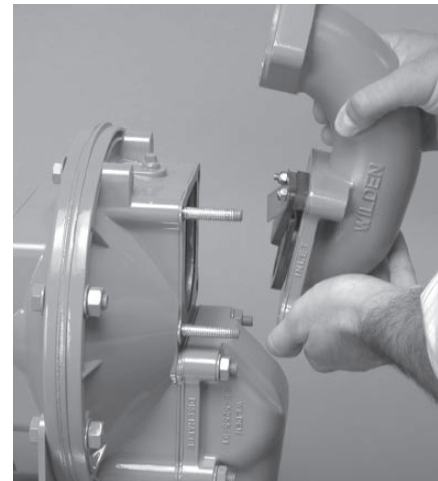

Step 9

Next, remove the remaining inlet elbow from the liquid chamber.



Step 10

Using a 9/16" wrench, remove the fasteners that connect the discharge elbow to the discharge T-section. To simplify this process, a socket extension can be used for easier access to the fastener.

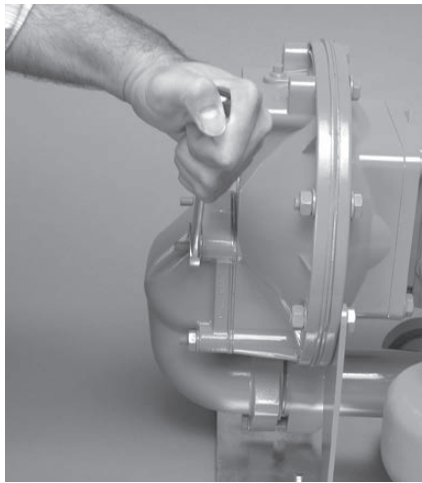

Step 11

Using a 9/16" wrench, remove the fasteners that connect the discharge elbow to the liquid chamber.

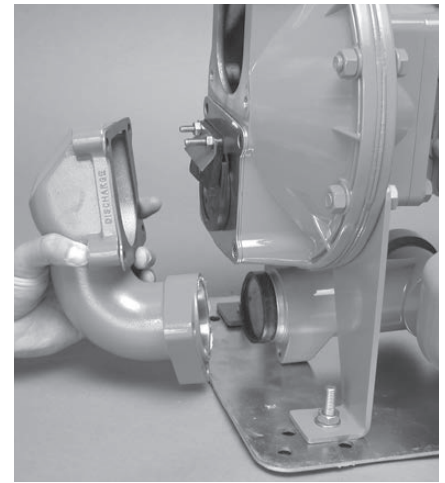

Step 12

Next, remove the discharge elbow from the liquid chamber.

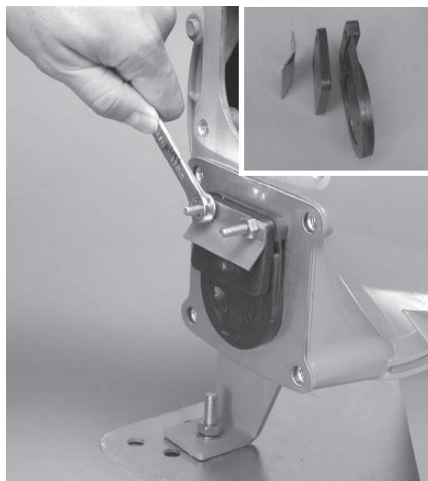

Step 13

Using a 7/16" wrench, remove the flap valve assembly from the liquid chamber. Inspect flap valves for nicks, gouges, chemical attack or abrasive wear. **NOTE:** Replace worn parts with genuine Wilden parts for reliable performance.



Step 14

Inspect manifold gasket, flap valve seat and seat gasket for nicks, gouges, chemical attack or abrasive wear.



Step 15

Using a 9/16" wrench, remove the fasteners that connect the remaining discharge elbow to the liquid chamber.

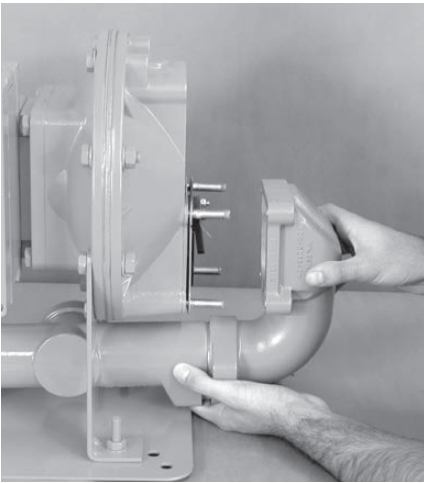

Step 16

Remove the discharge elbow and discharge T-section from the liquid chamber. This will allow for easy removal of the flap valve assembly. Inspect for nicks, gouges, chemical attack or abrasive wear.

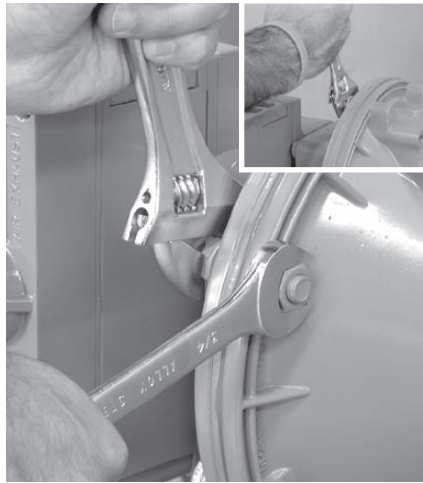

Step 17

Using a 5/8" wrench and an adjustable wrench, remove the fasteners that connect the liquid chambers to the center section.

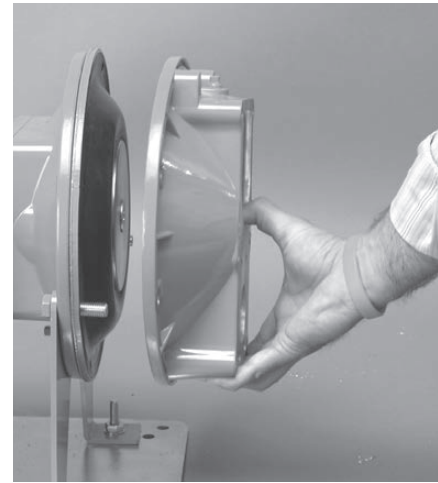

Step 18

Remove the liquid chamber to expose the diaphragm and outer piston.

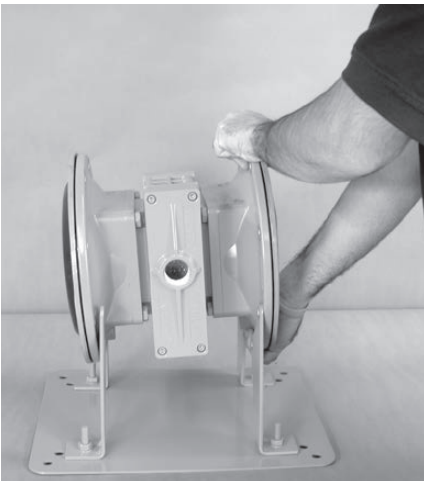

Step 19

Next, remove center section assembly from pump stand.



Step 20

Using two (2) 3/8" hex-head wrenches, loosen the outer piston from the main shaft.

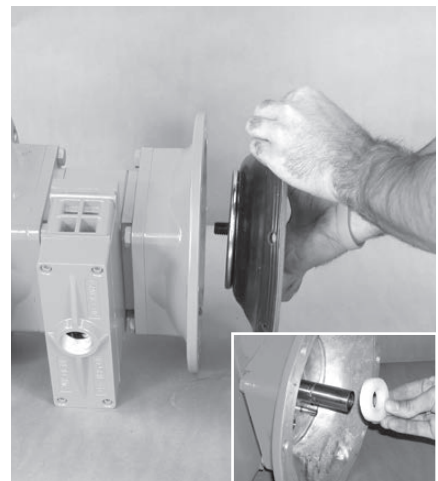

Step 21

After loosening the outer piston from the main shaft, the diaphragm assembly and bumper can be removed from the center section.

PUMP DISASSEMBLY

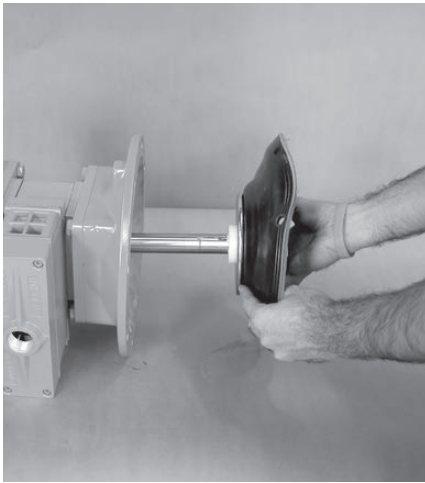

Step 22

Next, remove the remaining diaphragm/piston assembly, bumper and main shaft from the center section.

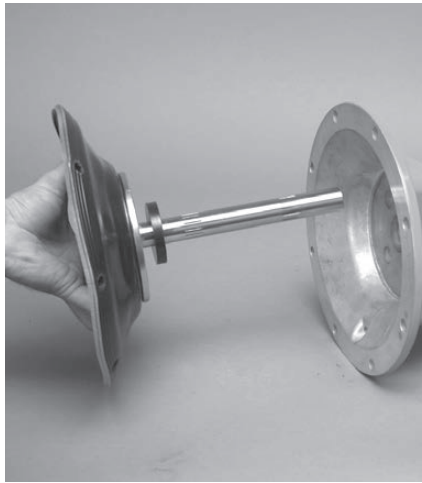

Step 23

Remove the inner piston from the diaphragm/piston assembly by turning counterclockwise.

AIR VALVE / CENTER SECTION DISASSEMBLY

TOOLS REQUIRED:

- 3/16" Hex-Head Wrench
- 1/4" Hex-Head Wrench
- O-Ring Pick

CAUTION: Before any maintenance or repair is attempted, the compressed air line to the pump should be disconnected and all air pressure allowed to bleed from the pump. Disconnect all intake, discharge and air lines. Drain the pump by turning it upside down and allowing any fluid to flow into a suitable container. Be aware of any hazardous effects of contact with your process fluid.

Wilden Pro-Flo® SHIFT metal pumps utilize a revolutionary Pro-Flo® SHIFT air distribution system. Proprietary composite seals reduce the coefficient of friction and allow the Pro-Flo® SHIFT to run lube-free. The Pro-Flo® SHIFT air distribution system is designed to perform in on/off, non-freezing, non-stalling, tough-duty applications.



Step 1

Using a pair of snap-ring pliers, remove the snap ring from pilot sleeve.



Step 2

Using an O-ring pick, remove O-ring from modulator spool.



Step 3

Using the appropriate-sized wrench, loosen and remove the fasteners that attach the air chamber to center section.

AIR VALVE / CENTER SECTION DISASSEMBLY

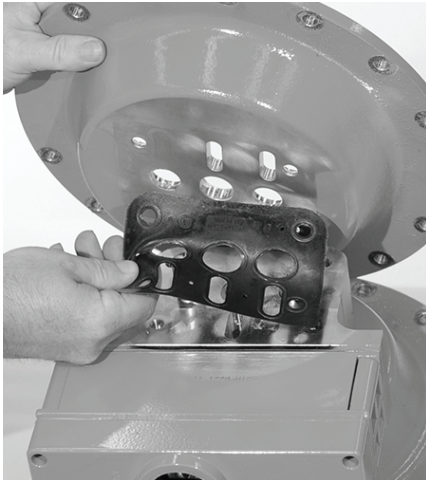

Step 4

Lift away air chamber from center section and remove center block gasket. Replace gasket if necessary.



Step 5

Turn assembly over and remove the pilot spool sleeve from the center section.



Step 6

Using an O-ring pick, gently remove the O-ring from the opposite side of the dimpled end of the pilot spool.



Step 7

Gently remove the pilot spool from the sleeve and inspect for nicks, wear or damage. Replace the pilot spool assembly or sleeve O-rings if necessary. During reassembly, never insert the dimpled end of the pilot spool first, this will damage the single urethane O-ring by passing it over the ports in the pilot sleeve.

NOTE: Seals should not be removed from the assembly. Seals are not sold separately.



Step 8

Remove modulator spool from center section. Check for wear to spool or O-rings and replace if necessary.



Step 9

Using the appropriate-sized wrench, loosen the fasteners and lift away remaining air chamber and center block gasket from center section. Replace gasket if necessary.

AIR VALVE / CENTER SECTION DISASSEMBLY

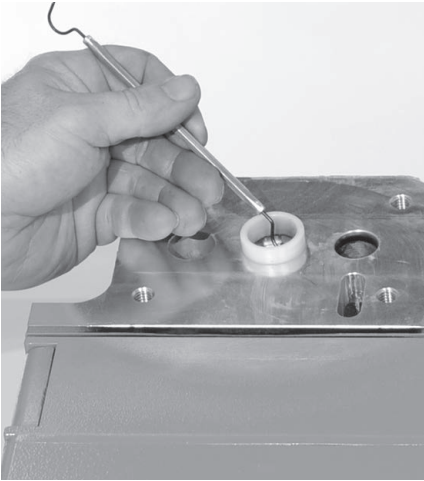

Step 10

Using an O-ring pick, remove the two (2) shaft bushings from center block. Inspect and replace if necessary. Using an O-ring pick, gently remove the two (2) Glyd™ rings from the center block. Inspect and replace if necessary.

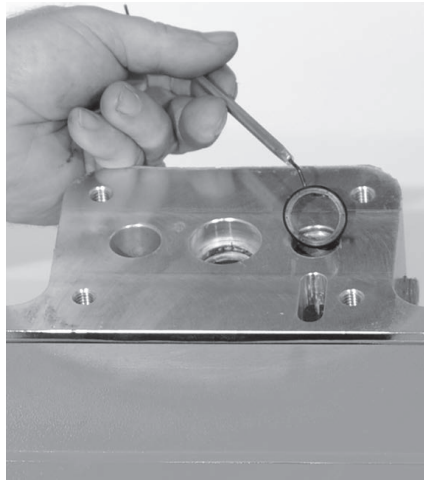

Step 11

Using an O-ring pick, remove the two (2) Glyd™ rings from modulator spool bore. Inspect and replace if necessary.



Step 12

Using an appropriate-sized wrench, remove the pilot exhaust muffler. Inspect for damage or contamination and replace if necessary.



Step 13

Using an appropriate-sized hex wrench, loosen and remove the four (4) air valve bolts from center section assembly.

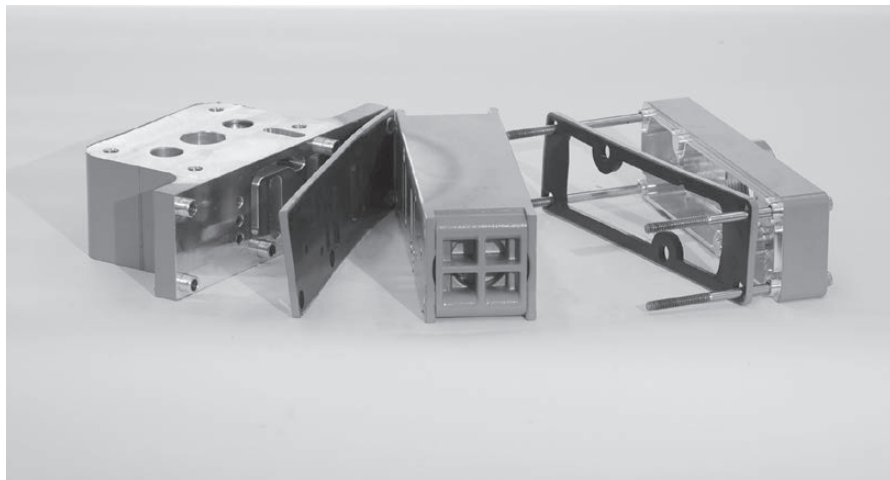

Step 14

Lift away muffer plate and muffer plate gasket from center block. Inspect for wear and replace if necessary. Lift away the air valve assembly and remove air valve gasket. Inspect the gasket and replace if necessary.

AIR VALVE / CENTER SECTION DISASSEMBLY

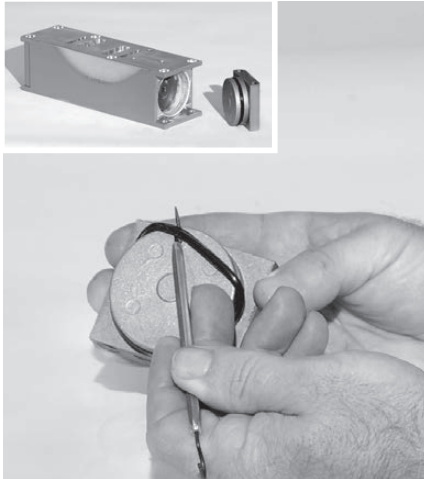

Step 15

Remove air valve end cap to expose air valve spool by lifting up on end cap. Inspect O-ring on end cap using an O-ring pick. Replace O-ring(s) if necessary. **NOTE:** The Pro-Flo® SHIFT air valve incorporates an end cap at both ends of the air valve.

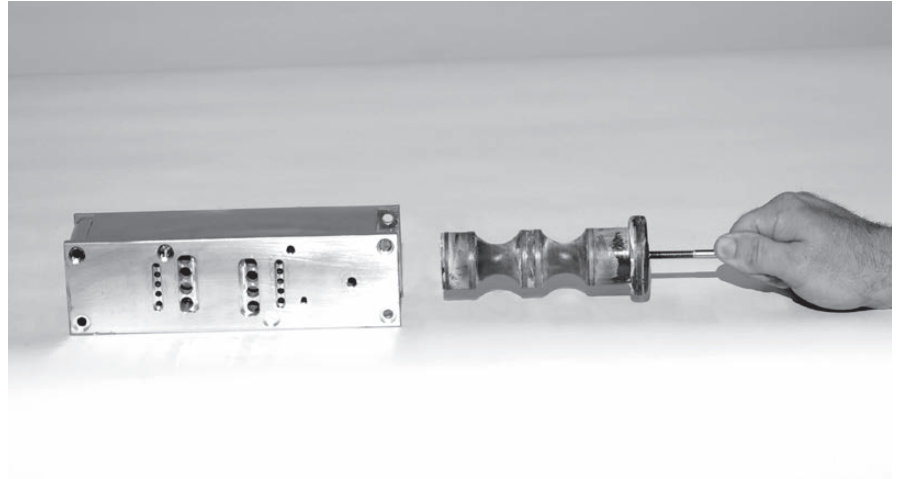

Step 16

Remove the air valve spool from the air valve body by threading one air valve bolt into the end of the air valve spool and gently sliding the spool out of the air valve body. Inspect seals for signs of wear and replace the entire air valve assembly if necessary. Re-insert the spool immediately into air valve body after inspection as the seals expand and cannot be reinserted after a length of time.

NOTE: Seals should not be removed from the assembly. Seals are not sold separately.

SINGLE-POINT EXHAUST PRO-FLO® SHIFT

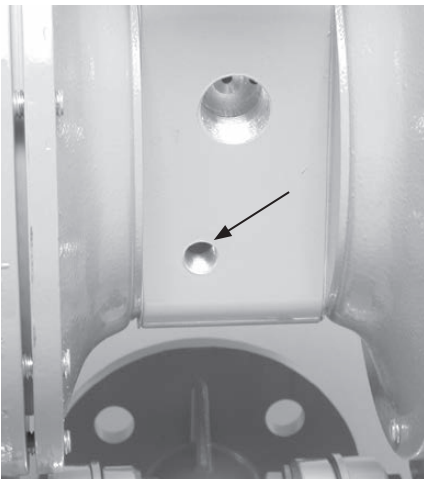

Step 1

Remove pilot exhaust muffler in pilot bleed port located at the front of the center block. Install 1/4" NPT pipe plug (00-7010-08) into bleed port.



Step 2

Next, install an optional single-point exhaust air valve gasket (04-2638-52). The single-point air valve gasket can be purchased as a spare part or included with the purchase of a new Pro-Flo® SHIFT pump.

REASSEMBLY HINTS & TIPS

ASSEMBLY:

Upon performing applicable maintenance to the air distribution system, the pump can now be reassembled. Please refer to the disassembly instructions for photos and parts placement. To reassemble the pump, follow the disassembly instructions in reverse order. The air distribution system needs to be assembled first, then the diaphragms and finally the wetted path. The following tips will assist in the assembly process.

- Lubricate air valve bore, center section shaft and pilot spool bore with NLGI grade 2 white EP bearing grease or equivalent.
- Clean the inside of the center section shaft bore to ensure no damage is done to new shaft seals.
- A small amount of NLGI grade 2 white EP bearing grease can be applied to the muffler and air valve gaskets to lubricate gaskets during assembly.
- Make sure that the exhaust port on the muffler plate is centered between the two exhaust ports on the center section.
- Stainless-steel bolts should be lubed to reduce the possibility of seizing during tightening.
- Use a mallet to tap lightly on the large clamp bands to seat the diaphragm before tightening.

PS810 MAXIMUM TORQUE SPECIFICATIONS

Description	Torque
Air Valve	13.6 N•m (120 in-lb)
Center Block to Air Chamber	27.1 N•m (20 ft-lb)
Outer Piston	54.2 N•m (40 ft-lb)
Flap Valve Assembly	1.7 N•m (15 in-lb)
Liquid Chamber to Air Chamber	32.5 N•m (24 ft-lb)
Manifold Elbow to Liquid Chamber	13.6 N•m (18 ft-lb)
Manifold Elbow to T-Section	20.3 N•m (15 ft-lb)

SHAFT SEAL INSTALLATION:

PRE-INSTALLATION

- Once all of the old seals have been removed, the inside of the bushing should be cleaned to ensure no debris is left that may cause premature damage to the new seals.

INSTALLATION

The following tools can be used to aid in the installation of the new seals:

Needle-Nose Pliers
Phillips Screwdriver
Electrical Tape

- Wrap electrical tape around each leg of the needle-nose pliers (heat shrink tubing may also be used). This is done to prevent damaging the inside surface of the new seal.
- With a new seal in hand, place the two legs of the needle-nose pliers inside the seal ring. (See Figure A.)
- Open the pliers as wide as the seal diameter will allow, then with two fingers pull down on the top portion of the seal to form a kidney shape. (See Figure B.)
- Lightly clamp the pliers together to hold the seal in the kidney shape. Be sure to pull the seal into as tight of a kidney shape as possible, this will allow the seal to travel down the bushing bore easier.
- With the seal clamped in the pliers, insert the seal into the bushing bore and position the bottom of the seal into the correct groove. Once the bottom of the seal is seated in the groove, release the clamp pressure on the pliers. This will allow the seal to partially snap back to its original shape.
- After the pliers are removed, you will notice a slight bump in the seal shape. Before the seal can be properly resized, the bump in the seal should be removed as much as possible. This can be done with either the Phillips screwdriver or your finger. With either the side of the screwdriver or your finger, apply light pressure to the peak of the bump. This pressure will cause the bump to be almost completely eliminated.
- Lubricate the edge of the shaft with NLGI grade 2 white EP bearing grease.
- Slowly insert the center shaft with a rotating motion. This will complete the resizing of the seal.
- Perform these steps for the remaining seals.

Figure A

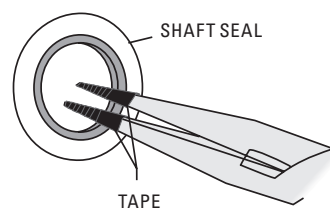
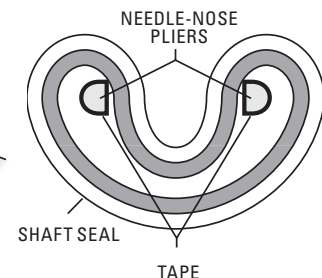

Figure B



NOTES



EXPLODED VIEW & PARTS LISTING

PS810 BRAHMA

EXPLODED VIEW

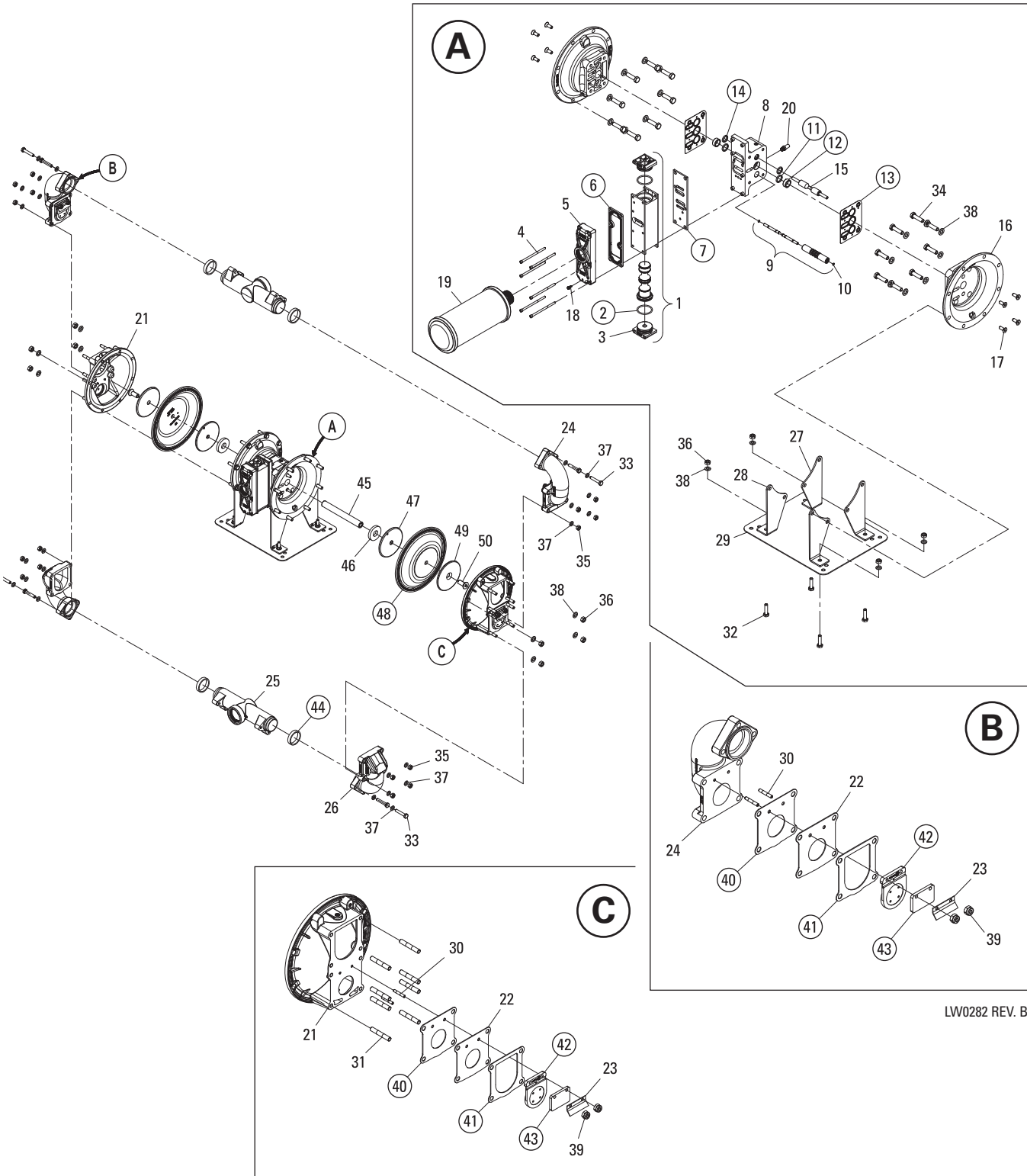

LW0282 REV. B



EXPLODED VIEW & PARTS LISTING

PS810 BRAHMA

PARTS LISTING

Item	Description	Qty.	XPS810/AMAAA/.../0677 P/N	XPS810/WMAAA/.../0677 P/N
AIR DISTRIBUTION COMPONENTS				
1	Air Valve Assembly, Pro-Flo® SHIFT¹	1	04-2039-01	04-2039-01
2	O-Ring (-225), End Cap (Ø1.859 x Ø.139)	2	04-2390-52-700	04-2390-52-700
3	End Cap	2	04-2340-01	04-2340-01
4	Screw, SHC, Air Valve (1/4"-20 x 4 1/2")	6	01-6000-03	01-6000-03
5	Muffler Plate, Pro-Flo® SHIFT	1	04-3189-01	04-3189-01
6	Gasket, Muffler Plate, Pro-Flo® SHIFT	1	04-3509-52	04-3509-52
7	Gasket, Air Valve, Pro-Flo® SHIFT	1	04-2639-52	04-2639-52
8	Center Block Assembly, Pro-Flo® SHIFT W ²	1	15-3129-01	15-3129-01
9	Pilot Sleeve Assembly	1	08-3894-99	08-3894-99
10	O-Ring, Pilot Spool Retaining (-009, Ø.208" x Ø.070")	2	04-2650-49-700	04-2650-49-700
11	Seal, Shaft	2	15-3210-55-225	15-3210-55-225
12	Bushing, Shaft	2	15-3306-13	15-3306-13
13	Gasket, Center Block Pro-Flo® SHIFT	2	04-3529-56	04-3529-56
14	O-Ring (-210, Ø.734" x Ø.139")	2	04-3209-49	04-3209-49
15	Air Control Spool	1	08-3854-03	08-3854-03
16	Air Chamber, Pro-Flo® SHIFT	2	08-3664-01	08-3664-01
17	Screw, SFCHC (3/8"-16 x 1")	8	71-6250-08	71-6250-08
18	Screw, Grounding, Self-tapping (10-32 x 1/2")	1	04-6345-08	04-6345-08
19	Muffler 1-1/2" MNPT	1	04-3518-99R	04-3518-99R
20	Muffler 1/4" MNPT	1	04-3240-07	04-3240-07
WETTED PATH COMPONENTS				
21	Chamber, Liquid	2	08-4985-01	08-4985-02
22	Seat, Flap Valve	4	08-1150-08	08-1150-08
23	Retainer, Flap Valve	4	08-1196-08	08-1196-08
24	Elbow, Inlet	2	08-5215-01	08-5215-02
25	T-Section (NPT)	2	08-5175-01	08-5175-02
	T-Section (BSPT)	2	08-5175-01-14	08-5175-02-14
26	Elbow, Discharge	2	08-5255-01	08-5255-02
27	Left - Hand Foot	2	08-5546-08	08-5546-08
28	Right - Hand Foot	2	08-5545-08	08-5545-08
29	Plate, Base	1	08-5550-08	08-5550-08
30	Stud, Threaded (1/4"-20 x 1-1/2")	8	08-6162-08	08-6162-08
31	Stud, Threaded (3/8"-16 x 2-1/2")	16	08-6161-08	08-6161-08
32	Screw, HHC, (7/16"-14 X 1-3/16)	4	08-6195-08	08-6195-08
33	Screw, HHC (3/8"-16 x 2-3/16")	8	08-6184-08	08-6184-08
34	Screw, HHC (7/16"-14 x 1-3/4")	16	08-6194-08	08-6194-08
35	Nut, Hex (3/8"-16)	16	02-6430-08	02-6430-08
36	Nut, Hex (7/16"-14)	12	08-6427-08	08-6427-08
37	Washer, Plain (Ø.406" x Ø.812" x .065")	24	15-6740-08-50	15-6740-08-50
38	Washer, Plain (Ø.468" x Ø.922" x .065")	28	08-6734-08	08-6734-08
39	Nut, Lock Hex (1/4"-20)	8	08-6477-08	08-6477-08
GASKETS/FLAP VALVES/FLAP HINGE/MANIFOLD SEAL RING				
40	Gasket, Seat	4	*	*
41	Gasket, Manifold	4	*	*
42	Valve, Flap	4	*	*
43	Pad, Flap Valve Hinge	4	*	*
44	Ring, Manifold Sealing	4	*	*
FULL-STROKE RUBBER COMPONENTS				
45	Shaft	1	08-3807-03	08-3807-03
46	Bumper	2	08-6902-23	08-6902-23
47	Piston, Inner	2	08-3705-08	08-3705-08
48	Diaphragm, Flap Valve	2	*	*
49	Piston, Outer	2	08-4555-08	08-4555-08
50	Screw, SFCHC (5/8"-11 x 1-1/2")	2	08-6092-08	08-6092-08

Specialty Code 0677 = Horizontal Center-Ported, NPT Threaded

Specialty Code 0678 = Horizontal Center Ported, BSPT Threaded

Specialty Code 0687 = Horizontal Center Ported, NPT Threaded, Single-Point Exhaust

Specialty Code 0688 = Horizontal Center Ported, BSPT Threaded, Single-Point Exhaust

*See elastomer chart - Section 9

²Center Block Assembly includes items 11, 12, 14, and 15.

LW0283 Rev. B

¹Air Valve Assembly includes items 2 and 3.

All boldface items are primary wear parts.

EXPLODED VIEW & PARTS LISTING

PS1510 BRAHMA

EXPLODED VIEW

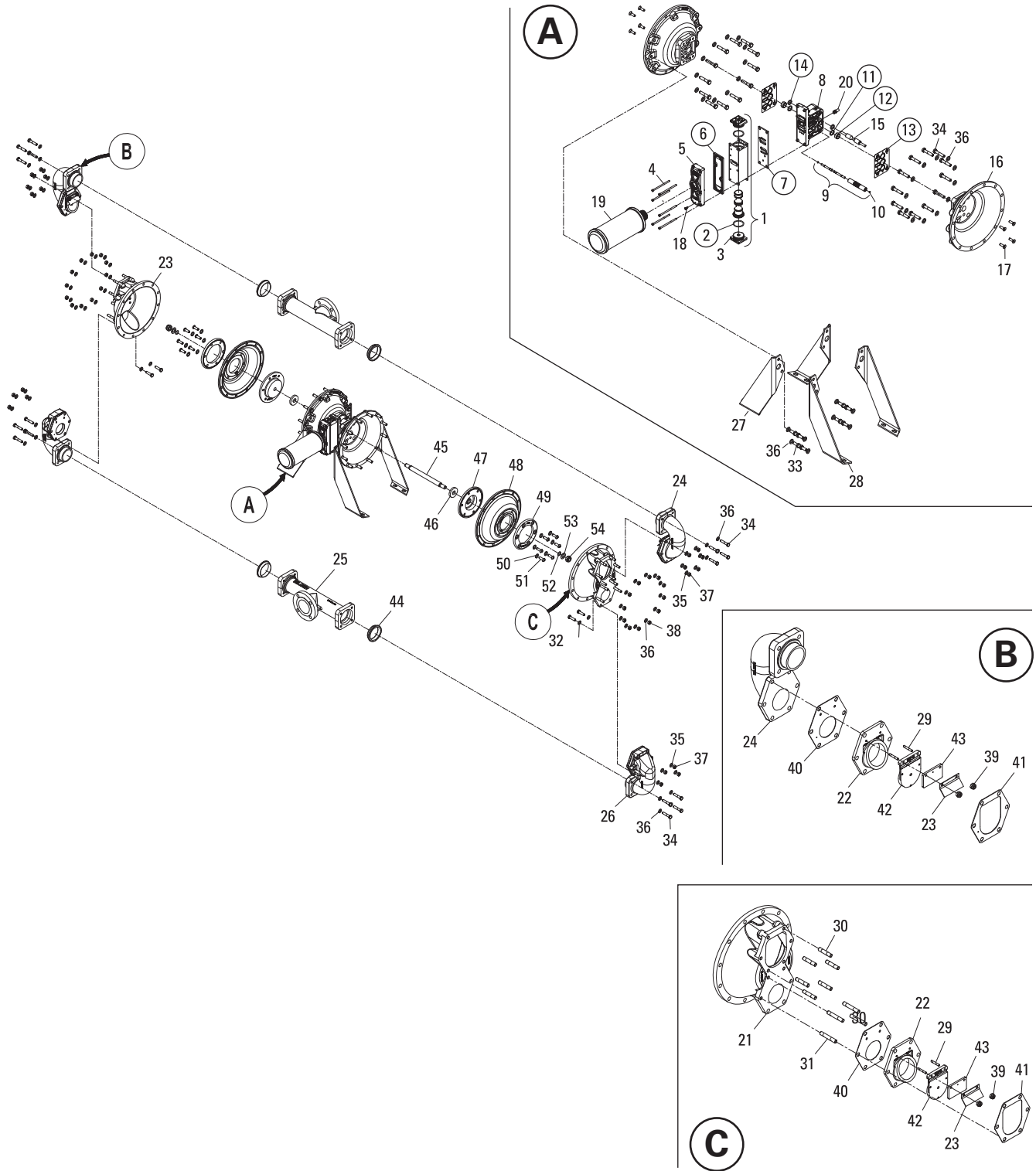

LW0285 REV. B



EXPLODED VIEW & PARTS LISTING

PS1510 BRAHMA

PARTS LISTING

Item	Description	Qty.	XPS1510/AAAAA/... P/N	XPS1510/WWAAA/... P/N
AIR DISTRIBUTION COMPONENTS				
1	Air Valve Assembly, Pro-Flo® SHIFT¹	1	04-2039-01	04-2039-01
2	O-Ring (-225), End Cap (Ø1.859 x Ø.139)	2	04-2390-52-700	04-2390-52-700
3	End Cap	2	04-2340-01	04-2340-01
4	Screw, SHC, Air Valve (1/4"-20 x 4 1/2")	6	01-6000-03	01-6000-03
5	Muffler Plate, Pro-Flo Shift™	1	04-3189-01	04-3189-01
6	Gasket, Muffler Plate, Pro-Flo® SHIFT	1	04-3509-52	04-3509-52
7	Gasket, Air Valve, Pro-Flo® SHIFT	1	04-2639-52	04-2639-52
8	Center Block Assembly, Pro-Flo® SHIFT ²	1	15-3129-01	15-3129-01
9	Pilot Sleeve Assembly	1	08-3894-99	08-3894-99
10	O-Ring, Pilot Spool Retaining (-009, Ø.208" x Ø.070")	2	04-2650-49-700	04-2650-49-700
11	Seal, Shaft	2	15-3210-55-225	15-3210-55-225
12	Bushing, Shaft	2	15-3306-13	15-3306-13
13	Gasket, Center Block Pro-Flo® SHIFT	2	04-3529-56	04-3529-56
14	O-Ring (-210, Ø.734" x Ø.139")	2	04-3209-49	04-3209-49
15	Air Control Spool	1	15-3854-03	15-3854-03
16	Air Chamber, Pro-Flo® SHIFT	2	15-3664-01	15-3664-01
17	Screw, SFCHC (3/8"-16 x 1")	8	71-6250-08	71-6250-08
18	Screw, Grounding, Self-tapping (10-32 x 1/2")	1	04-6345-08	04-6345-08
19	Muffler 1-1/2" MNPT	1	04-3518-99R	04-3518-99R
20	Muffler 1/4" MNPT	1	04-3240-07	04-3240-07
WETTED PATH COMPONENTS				
21	Chamber, Liquid	2	15-4985-01	15-4985-02
22	Seat, Flap Valve	4	15-1150-01	15-1150-02
23	Retainer, Flap Valve	4	15-1196-08	15-1196-08
24	Elbow, Inlet	2	15-5215-01	15-5215-02
25	T-Section (ANSI)	2	15-5175-01	15-5175-02
	T-Section (DIN)	2	15-5176-01	15-5176-02
26	Elbow, Discharge	2	15-5255-01	15-5255-02
27	Left - Hand Foot	2	15-5546-08	15-5546-08
28	Right - Hand Foot	2	15-5545-08	15-5545-08
29	Stud, Threaded (1/4"-20 x 1-1/2")	8	08-6162-08	08-6162-08
30	Stud, Threaded (7/16"-14 x 2-3/8")	12	15-6161-08	15-6161-08
31	Stud, Threaded (7/16"-14 x 3-3/16")	8	15-6162-08	15-6162-08
32	Screw, HHC (7/16"-14 x 1-3/4")	4	08-6194-08	08-6194-08
33	Screw, HHC (1/2"-13 x 1")	8	08-6132-08	08-6132-08
34	Screw, HHC (1/2"-13 x 2-3/8")	40	15-6184-08	15-6184-08
35	Washer, Plain (7/16")	24	08-6734-08	08-6734-08
36	Washer, Plain (1/2")	72	04-6730-08	04-6730-08
37	Nut, Hex (7/16"-14)	20	08-6427-08	08-6427-08
38	Nut, Hex (1/2"-13)	24	15-6420-08	15-6420-08
39	Nut, Lock Hex (1/4"-20)	8	08-6477-08	08-6477-08
GASKETS/FLAP VALVES/FLAP HINGE/MANIFOLD SEAL RING				
40	Gasket, Seat	4	*	*
41	Gasket, Manifold	4	*	*
42	Valve, Flap	4	*	*
43	Pad, Flap Valve Hinge	4	*	*
44	Ring, Manifold Sealing	4	*	*
FULL-STROKE RUBBER COMPONENTS				
45	Shaft	1	15-3807-03	15-3807-03
46	Bumper	2	08-6902-23	08-6902-23
47	Piston, Inner	2	15-3705-01	15-3705-02
48	Diaphragm, Flap Valve	2	*	*
49	Piston, Outer	2	15-4555-01	15-4555-02
50	Washer, Brass (.63 ID x 1.00 OD x .05)	12	15-6741-07	15-6741-07
51	Screw, BHC (1/2"-13 x 1-3/8")	12	15-6194-08	15-6194-08
52	Washer, Plain (3/4")	2	15-6743-08	15-6743-08
53	Washer, Brass (.79 ID x .98 OD x .04)	2	15-6742-07	15-6742-07
54	Nut, Lock Hex (3/4"-10)	2	15-6461-08	15-6461-08

Specialty Code 0504 = Horizontal Center Ported, DIN-Flanged

Specialty Code 0320 = Single-Point Exhaust

Specialty Code 0323 = Single-Point Exhaust, DIN-Flanged

*See elastomer chart - Section 9

¹Air Valve Assembly includes items 2 and 3.

²Center Block Assembly includes items 11, 12, 14, and 15.

All boldface items are primary wear parts.



ELASTOMER OPTIONS

PS810 BRAHMA

MATERIAL	DIAPHRAGMS, FLAP VALVE	GASKETS, SEAT	GASKETS, MANIFOLD	VALVES, FLAP	PADS, FLAP-VALVE HINGE	RINGS, MANIFOLD SEALING
Neoprene	08-1012-51	08-1395-51	08-1401-51	08-1185-51	08-1195-51	08-1305-51
Buna-N	08-1012-52	08-1395-52	08-1401-52	08-1185-52	08-1195-52	08-1305-52

LW0283 Rev. B

PS1510 BRAHMA

MATERIAL	DIAPHRAGMS, FLAP VALVE	GASKETS, SEAT	GASKETS, MANIFOLD	VALVES, FLAP	PADS, FLAP-VALVE HINGE	RINGS, MANIFOLD SEALING
Neoprene	15-1012-51	15-1395-51	15-1401-51	15-1185-51	15-1195-51	15-1305-51
Buna-N	15-1012-52	15-1395-52	15-1401-52	15-1185-52	15-1195-52	15-1305-52

LW0286 Rev. B

NOTES

NOTES

NOTES

WARRANTY

Each and every product manufactured by Wilden Pump and Engineering, LLC is built to meet the highest standards of quality. Every pump is functionally tested to insure integrity of operation.

Wilden Pump and Engineering, LLC warrants that pumps, accessories and parts manufactured or supplied by it to be free from defects in material and workmanship for a period of five (5) years from date of installation or six (6) years from date of manufacture, whichever comes first. Failure due to normal wear, misapplication, or abuse is, of course, excluded from this warranty.

Since the use of Wilden pumps and parts is beyond our control, we cannot guarantee the suitability of any pump or part for a particular application and Wilden Pump and Engineering, LLC shall not be liable for any consequential damage or expense arising from the use or misuse of its products on any application. Responsibility is limited solely to replacement or repair of defective Wilden pumps and parts.

All decisions as to the cause of failure are the sole determination of Wilden Pump and Engineering, LLC.

Prior approval must be obtained from Wilden for return of any items for warranty consideration and must be accompanied by the appropriate MSDS for the product(s) involved. A Return Goods Tag, obtained from an authorized Wilden distributor, must be included with the items which must be shipped freight prepaid.

The foregoing warranty is exclusive and in lieu of all other warranties expressed or implied (whether written or oral) including all implied warranties of merchantability and fitness for any particular purpose. No distributor or other person is authorized to assume any liability or obligation for Wilden Pump and Engineering, LLC other than expressly provided herein.

PLEASE PRINT OR TYPE AND FAX TO WILDEN

PUMP INFORMATION			
Item # _____		Serial # _____	
Company Where Purchased _____			
YOUR INFORMATION			
Company Name _____			
Industry _____			
Name _____		Title _____	
Street Address _____			
City _____	State _____	Postal Code _____	Country _____
Telephone _____	Fax _____	E-mail _____	Web Address _____
Number of pumps in facility? _____		Number of Wilden pumps? _____	
Types of pumps in facility (check all that apply): <input type="checkbox"/> Diaphragm <input type="checkbox"/> Centrifugal <input type="checkbox"/> Gear <input type="checkbox"/> Submersible <input type="checkbox"/> Lobe			
<input type="checkbox"/> Other _____			
Media being pumped? _____			
How did you hear of Wilden Pump? <input type="checkbox"/> Trade Journal <input type="checkbox"/> Trade Show <input type="checkbox"/> Internet/E-mail <input type="checkbox"/> Distributor			
<input type="checkbox"/> Other _____			

ONCE COMPLETE, FAX TO (909) 783-3440

OR GO TO PSGDOVER.COM > WILDEN > SUPPORT TO COMPLETE THE WARRANTY REGISTRATION ONLINE

NOTE: WARRANTY VOID IF PAGE IS NOT FAXED TO WILDEN OR SUBMITTED ONLINE VIA THE PSGDOVER.COM WEBSITE

WILDEN PUMP & ENGINEERING, LLC



Where Innovation Flows

PSG reserves the right to modify the information and illustrations contained in this document without prior notice. This is a non-contractual document. 02-2017

WILDEN®

PSG

22069 Van Buren St., Grand Terrace, CA 92313-5607

P: +1 (909) 422-1730 • F: +1 (909) 783-3440

wildenpump.com

Authorized PSG Representative:

Copyright ©2017, PSG, A Dover Company