

WILDEN®

EOM

Engineering
Operation &
Maintenance

PX8
Saniflo™ Hygienic Series
Metal Pumps

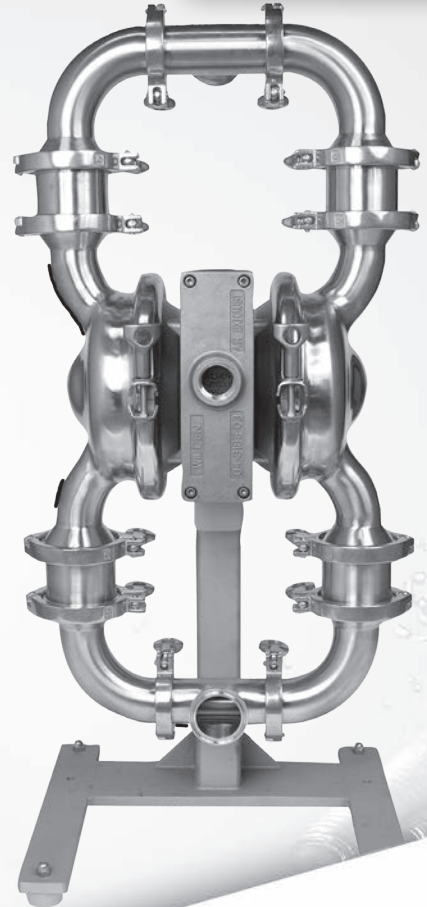

Where Innovation Flows

wildenpump.com



WIL-12310-E-06
REPLACES WIL-12310-E-05

TABLE OF CONTENTS

SECTION 1 CAUTIONS—READ FIRST! 1

SECTION 2 WILDEN PUMP DESIGNATION SYSTEM 2

SECTION 3 HOW IT WORKS—PUMP & AIR DISTRIBUTION SYSTEM 3

SECTION 4 DIMENSIONAL DRAWINGS 4

SECTION 5 PERFORMANCE

 A. PX8 Performance Curves 7

 Operating Principle 8

 How to Use this Curve 9

 Rubber-Fitted 12

 TPE-Fitted 13

 Full-Stroke PTFE-Fitted 14

 Full-Stroke Integral Piston Diaphragm-Fitted 15

 Reduced-Stroke PTFE-Fitted 16

 Reduced-Stroke PTFE Integral Piston Diaphragm-Fitted 17

 Reduced-Stroke Ultra-Flex™ -Fitted 18

 B. Suction-Lift Curves 19

SECTION 6 SUGGESTED INSTALLATION, OPERATION & TROUBLESHOOTING 21

SECTION 7 DISASSEMBLY / REASSEMBLY 24

SECTION 8 CLEAN IN PLACE - CIP 33

SECTION 9 EXPLODED VIEW & PARTS LISTING



















 PX8 Saniflo™ HS 34

 PX8 Saniflo™ HS 1935/2004/EC 38

SECTION 10 ELASTOMER OPTIONS 41



CAUTIONS—READ FIRST!

-  **CAUTION:** Do not apply compressed air to the exhaust port — pump will not function.
-  **CAUTION:** Do not over-lubricate air supply — excess lubrication will reduce pump performance. Pump is pre-lubed.
-  **TEMPERATURE LIMITS:**
- | | | |
|---|----------------|----------------|
| Polypropylene | 0°C to 79°C | 32°F to 175°F |
| PVDF | -12°C to 107°C | 10°F to 225°F |
| PFA | 7°C to 107°C | 20°F to 225°F |
| Neoprene | -18°C to 93°C | 0°F to 200°F |
| Buna-N | -12°C to 82°C | 10°F to 180°F |
| EPDM | -51°C to 138°C | -60°F to 280°F |
| Viton® FKM | -40°C to 177°C | -40°F to 350°F |
| Wil-Flex™ | -40°C to 107°C | -40°F to 225°F |
| Saniflex™ | -29°C to 104°C | -20°F to 220°F |
| Polyurethane | -12°C to 66°C | 10°F to 150°F |
| Polytetrafluoroethylene (PTFE) ¹ | 4°C to 104°C | 40°F to 220°F |
| Nylon | -18°C to 93°C | 0°F to 200°F |
| Acetal | -29°C to 82°C | -20°F to 180°F |
| SIPD PTFE with Neoprene-backed | 4°C to 104°C | 40°F to 220°F |
| SIPD PTFE with EPDM-backed | 4°C to 137°C | 40°F to 280°F |
| Geolast® | -40°C to 82°C | -40°F to 180°F |
- ¹4°C to 149°C (40°F to 300°F) - 13 mm (1/2") and 25 mm (1") models only.
- NOTE: Not all materials are available for all models. Refer to Section 2 for material options for your pump.
-  **CAUTION:** When choosing pump materials, be sure to check the temperature limits for all wetted components. Example: Viton® has a maximum limit of 177°C (350°F), but polypropylene has a maximum limit of only 79°C (175°F).
-  **CAUTION:** Maximum temperature limits are based upon mechanical stress only. Certain chemicals will significantly reduce maximum safe operating temperatures. Consult Chemical Resistance Guide for chemical compatibility and temperature limits.
-  **WARNING:** Prevent static sparking. If static sparking occurs, fire or explosion could result. Pump, valves and containers must be grounded to a proper grounding point when handling flammable fluids and whenever discharge of static electricity is a hazard.
-  **CAUTION:** Do not exceed 8.6 bar (125 psig) air supply pressure.
-  **CAUTION:** The process fluid and cleaning fluids must be chemically compatible with all wetted pump components. Consult Chemical Resistance Guide.
-  **CAUTION:** Do not exceed 82°C (180°F) air inlet temperature for Pro-Flo X™ models.
-  **CAUTION:** Pumps should be thoroughly flushed before installing into process lines. FDA- and USDA-approved pumps should be cleaned and/or sanitized before being used.
-  **CAUTION:** Always wear safety glasses when operating pump. If diaphragm rupture occurs, material being pumped may be forced out air exhaust.
-  **CAUTION:** Before any maintenance or repair is attempted, the compressed air line to the pump should be disconnected and all air pressure allowed to bleed from pump. Disconnect all intake, discharge and air lines. Drain the pump by turning it upside down and allowing any fluid to flow into a suitable container.
-  **CAUTION:** Blow out air line for 10 to 20 seconds before attaching to pump to make sure all pipeline debris is clear. Use an in-line air filter. A 5µ (micron) air filter is recommended.
-  **NOTE:** When installing PTFE diaphragms, it is important to tighten outer pistons simultaneously (turning in opposite directions) to ensure tight fit. When installing IPDs and FSIPDs, these diaphragms cannot be over-tightened by hand; do not use tools when tightening. (See torque specifications in Section 7.)
-  **NOTE:** Cast Iron PTFE-fitted pumps come standard from the factory with expanded PTFE gaskets installed in the diaphragm bead of the liquid chamber. PTFE gaskets cannot be re-used.
-  **NOTE:** Before starting disassembly, mark a line from each liquid chamber to its corresponding air chamber. This line will assist in proper alignment during reassembly.
-  **CAUTION:** Pumps are available in both submersible and non-submersible options. Do not use standard models in submersible applications.
-  **CAUTION:** Tighten all hardware prior to installation.



WILDEN PUMP DESIGNATION SYSTEM

**PX8 SANIFLO™
HYGIENIC SERIES**

**51 mm (2") Pump
Maximum Flow Rate:
587 lpm (155 gpm)**

LEGEND

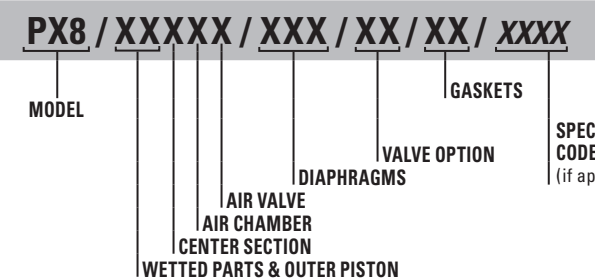

MATERIAL CODES

MODEL

PX8 = 51 mm (2")
XPX8 = 51 mm (2") ATEX

**WETTED PARTS/
OUTER PISTON**

SS = 316L STAINLESS STEEL
SZ = 316L STAINLESS STEEL/
NO PISTON

CENTER BLOCK

N = NICKEL-PLATED ALUMINUM
S = 316 STAINLESS STEEL

AIR CHAMBERS

N = NICKEL-PLATED ALUMINUM
S = 316 STAINLESS STEEL

AIR VALVE

N = NICKEL-PLATED ALUMINUM
S = 316 STAINLESS STEEL

DIAPHRAGMS

BNU = ULTRA-FLEX™ BUNA^{1,5,6}
EPU = ULTRA-FLEX™ EPDM^{1,5,6}
FBS = SANITARY BUNA^{1,6}
(Two Yellow Dots)
FES = SANITARY EPDM^{1,6}
(Two Blue Dots)
FSS = SANIFLEX™^{1,6}
FWL = FULL-STROKE SANITARY
WIL-FLEX™ IPD^{1,3,4,6}
FWS = SANITARY WIL-FLEX™,
EZ-INSTALL [Santoprene®
(Two Orange Dots)]^{1,6}
LEL = PTFE IPD^{1,2,3,4,5,6}
TEU = PTFE w/EPDM BACKUP^{1,2,5,6}
TSS = FULL-STROKE PTFE
w/SANIFLEX™ BACK-UP^{1,2,6}
TSU = PTFE w/SANIFLEX™
BACK-UP^{1,2,5,6}
TWS = FULL-STROKE PTFE
w/WIL-FLEX™ BACK-UP^{1,2,6}
ZSS = SANIFLEX™, EZ-INSTALL^{1,3}

**VALVE BALLS, FLAP VALVES,
MUSHROOM CHECK**

FB = SANITARY BUNA^{1,3,4,6}
(Red Dot)
FE = SANITARY EPDM^{1,3,4,6}
(Green Dot)
FS = SANIFLEX™^{1,3,4,6}
FW = SANITARY WIL-FLEX™
[Santoprene® (Two Orange
Dots)]^{1,3,4,6}
SF = STAINLESS STEEL FLAP^{1,5,6}
TF = PTFE^{1,2,3,4,6}
TM = PTFE MUSHROOM
CHECK^{1,2,6}

MANIFOLD GASKET

FB = SANITARY BUNA-N^{1,3,4,6}
(Red Dot)
FE = SANITARY EPDM^{1,3,4,6}
(Green Dot)
FV = SANITARY VITON®^{1,3,4,6}
(One White/One Yellow Dot)
TF = PTFE^{1,2,3,4,5,6}

NOTE:

- ¹Meets Requirements of FDA CFR21.177
- ²Meets Requirements of USPC Class VI
- ³Required for EHEDG Certification
- ⁴Required for 3-A Certification
- ⁵Stainless flap valve not available with reduced-stroke PTFE, reduced-stroke Ultra-Flex™ or reduced-stroke Laminate IP diaphragms
- ⁶Meets Requirements of 1935/2004/EC

SPECIALTY CODES

- | | |
|---|---|
| 0770 Saniflo HS | 0770E Saniflo HS (1935/2004/EC) |
| 0771 Saniflo HS, w/Swivel Stand | 0771E Saniflo HS, w/Swivel Stand (1935/2004/EC) |
| 0772 Saniflo HS, Wil-Gard 110V | 0772E Saniflo HS, Wil-Gard 110V (1935/2004/EC) |
| 0773 Saniflo HS, Wil-Gard 220V | 0773E Saniflo HS, Wil-Gard 220V (1935/2004/EC) |
| 0774 Saniflo HS, Wil-Gard 110V, w/Swivel Stand | 0774E Saniflo HS, Wil-Gard 110V, w/Swivel Stand (1935/2004/EC) |
| 0775 Saniflo HS, Wil-Gard 220V, w/Swivel Stand | 0775E Saniflo HS, Wil-Gard 220V, w/Swivel Stand (1935/2004/EC) |
| 0778 Saniflo HS, DIN Connection | 0778E Saniflo HS, DIN Connection (1935/2004/EC) |
| 0779 Saniflo HS, w/Swivel Stand DIN Connection | 0779E Saniflo HS, w/Swivel Stand DIN Connection (1935/2004/EC) |
| 0780 Saniflo HS, Wil-Gard 110V DIN Connection | 0780E Saniflo HS, Wil-Gard 110V DIN Connection (1935/2004/EC) |
| 0781 Saniflo HS, Wil-Gard 220V DIN Connection | 0781E Saniflo HS, Wil-Gard 220V DIN Connection (1935/2004/EC) |
| 0782 Saniflo HS, Wil-Gard 110V, w/Swivel Stand DIN Connection | 0782E Saniflo HS, Wil-Gard 110V, w/Swivel Stand DIN Connection (1935/2004/EC) |
| 0783 Saniflo HS, Wil-Gard 220V, w/Swivel Stand DIN Connection | 0783E Saniflo HS, Wil-Gard 220V, w/Swivel Stand DIN Connection (1935/2004/EC) |
| 0784 Saniflo HS, SMS Connection | 0784E Saniflo HS, SMS Connection (1935/2004/EC) |
| 0785 Saniflo HS, w/Swivel Stand SMS Connection | 0785E Saniflo HS, w/Swivel Stand SMS Connection (1935/2004/EC) |
| 0786 Saniflo HS, Wil-Gard 110V SMS Connection | 0786E Saniflo HS, Wil-Gard 110V SMS Connection (1935/2004/EC) |
| 0787 Saniflo HS, Wil-Gard 220V SMS Connection | 0787E Saniflo HS, Wil-Gard 220V SMS Connection (1935/2004/EC) |
| 0788 Saniflo HS, Wil-Gard 110V, w/Swivel Stand SMS Connection | 0788E Saniflo HS, Wil-Gard 110V, w/Swivel Stand SMS Connection (1935/2004/EC) |
| 0789 Saniflo HS, Wil-Gard 220V, w/Swivel Stand SMS Connection | 0789E Saniflo HS, Wil-Gard 220V, w/Swivel Stand SMS Connection (1935/2004/EC) |

NOTE: MOST ELASTOMERIC MATERIALS USE COLORED DOTS FOR IDENTIFICATION.
Viton® is a registered trademark of DuPont Dow Elastomers.



HOW IT WORKS—PUMP

The Wilden diaphragm pump is an air-operated, positive displacement, self-priming pump. These drawings show flow pattern through the pump upon its initial stroke. It is assumed the pump has no fluid in it prior to its initial stroke.

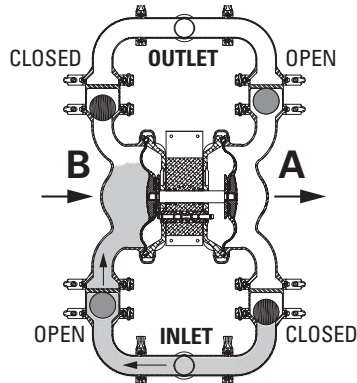

FIGURE 1 The air valve directs pressurized air to the back side of diaphragm A. The compressed air is applied directly to the liquid column separated by elastomeric diaphragms. The diaphragm acts as a separation membrane between the compressed air and liquid; a balanced load removes mechanical stress from the diaphragm. The compressed air moves the diaphragm away from the center of the pump. The opposite diaphragm is pulled in by the shaft connected to the pressurized diaphragm. Diaphragm B is on its suction stroke; air behind the diaphragm has been forced out to the atmosphere through the exhaust port of the pump. The movement of diaphragm B toward the center of the pump creates a vacuum within chamber B. Atmospheric pressure forces fluid into the inlet manifold forcing the inlet valve ball off its seat. Liquid is free to move past the inlet valve ball and fill the liquid chamber (see shaded area).

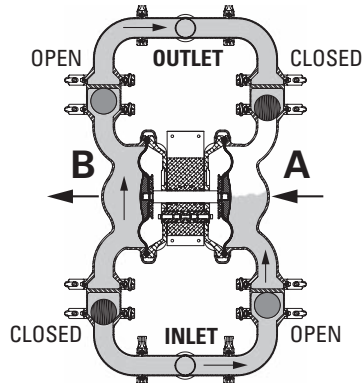

FIGURE 2 When the pressurized diaphragm, diaphragm A, reaches the limit of its discharge stroke, the air valve redirects pressurized air to the back side of diaphragm B. The pressurized air forces diaphragm B away from the center while pulling diaphragm A to the center. Diaphragm B is now on its discharge stroke. Diaphragm B forces the inlet valve ball onto its seat due to the hydraulic forces developed in the liquid chamber and manifold of the pump. These same hydraulic forces lift the discharge valve ball off its seat, forcing fluid to flow through the pump discharge. The movement of diaphragm A toward the center of the pump creates a vacuum within liquid chamber A. Atmospheric pressure forces fluid into the inlet manifold of the pump. The inlet valve ball is forced off its seat allowing the fluid being pumped to fill the liquid chamber.

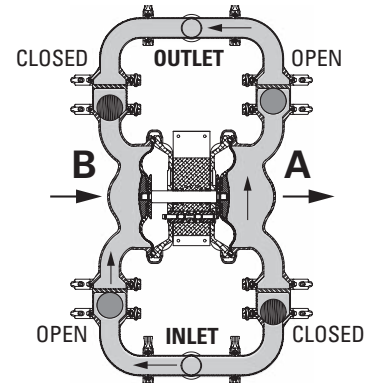
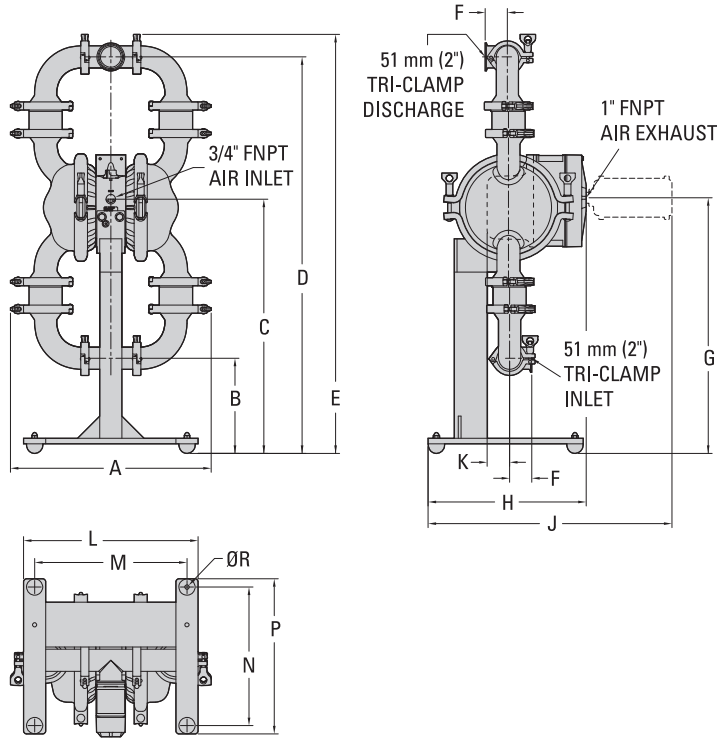

FIGURE 3 At completion of the stroke, the air valve again redirects air to the back side of diaphragm A, which starts diaphragm B on its exhaust stroke. As the pump reaches its original starting point, each diaphragm has gone through one exhaust and one discharge stroke. This constitutes one complete pumping cycle. The pump may take several cycles to completely prime depending on the conditions of the application.



DIMENSIONAL DRAWINGS

PX8 Saniflo™ HS Vertically-Mounted, Center-Ported with Ball/Mushroom Valve



DIMENSIONS

ITEM	METRIC (mm)	STANDARD (inch)
A	460	18.1
B	218	8.6
C	583	22.9
D	909	35.8
E	960	37.8
F	51	2
G	586	23.1
H	363	14.3
J	559	22.0
K	46	1.8
L	401	15.8
M	351	13.8
N	318	12.5
P	356	14.0
R	ø10	ø0.4

LW0110, Rev. A

PX8 Saniflo™ HS Flap-Valve Fixed

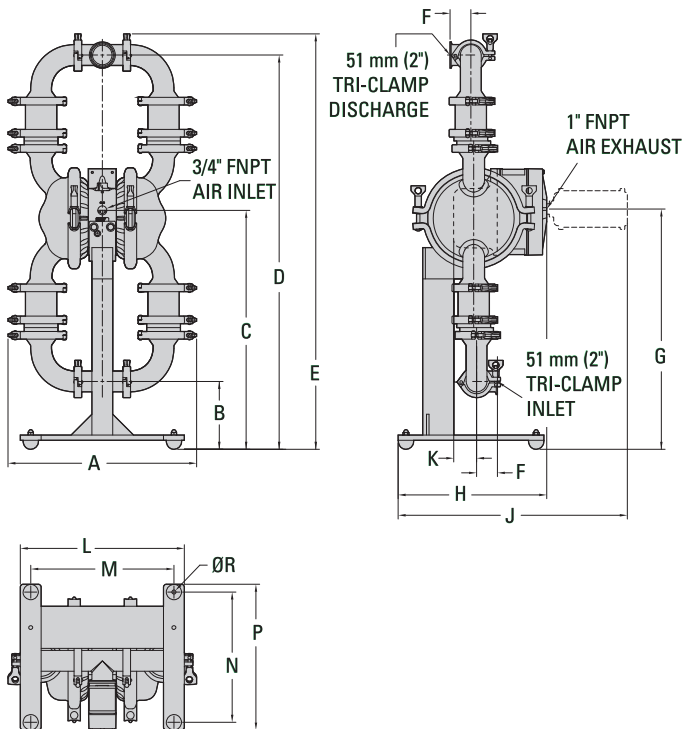

DIMENSIONS

ITEM	METRIC (mm)	STANDARD (inch)
A	460	18.1
B	165	6.5
C	583	22.9
D	962	37.9
E	1013	39.9
F	51	2
G	586	23.1
H	363	14.3
J	559	22.0
K	56	2.2
L	401	15.8
M	351	13.8
N	318	12.5
P	356	14.0
R	ø10	ø0.4

LW0111, Rev. A

PX8 Saniflo™ HS Swivel

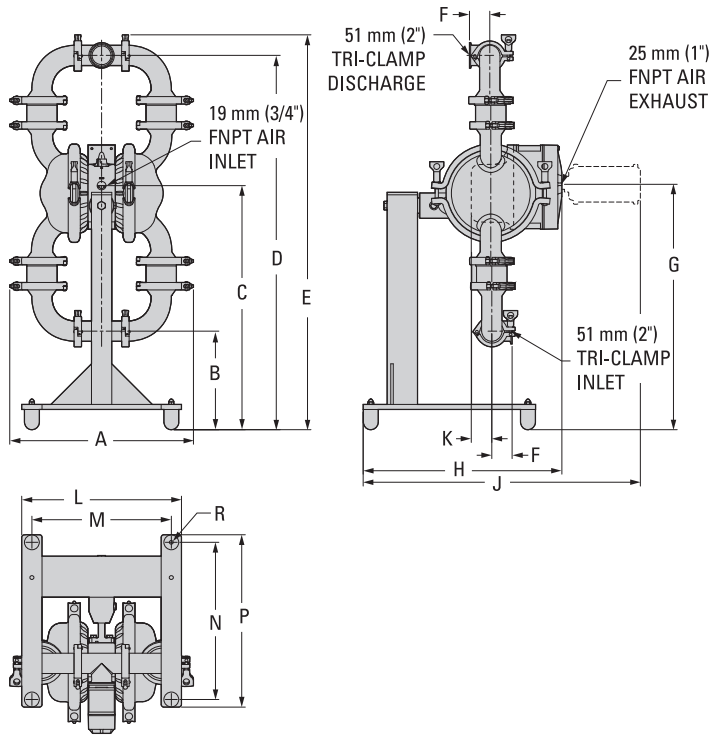

DIMENSIONS

ITEM	METRIC (mm)	STANDARD (inch)
A	460	18.1
B	247	9.7
C	612	24.1
D	938	36.9
E	989	38.9
F	51	2.0
G	615	24.2
H	498	19.6
J	693	27.3
K	46	1.8
L	401	15.8
M	351	13.8
N	394	15.5
P	432	17.0
R	ø10	ø.4

Rev B

PX8 Saniflo™ HS Flap-Valve Swivel

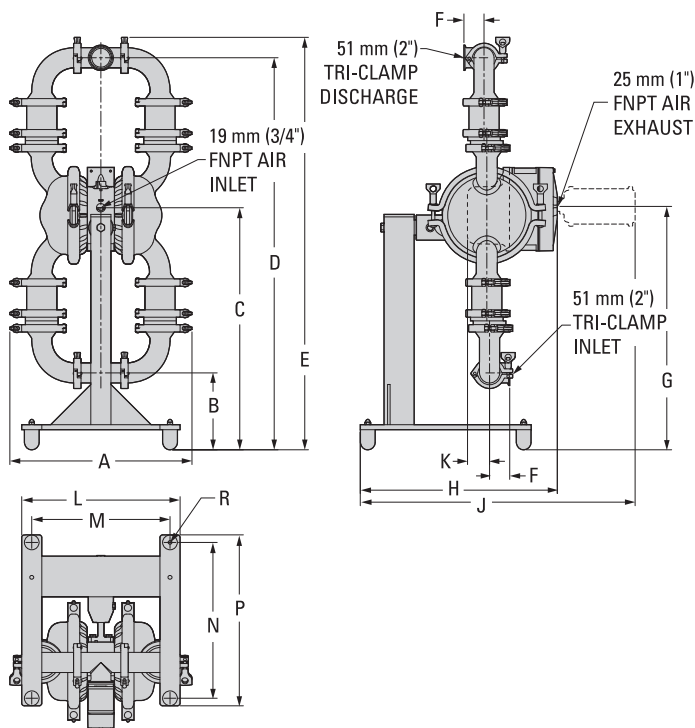

DIMENSIONS

ITEM	METRIC (mm)	STANDARD (inch)
A	460	18.1
B	194	7.6
C	612	24.1
D	990	39.0
E	1042	41.0
F	51	2.0
G	615	24.2
H	498	19.6
J	693	27.3
K	56	2.2
L	401	15.8
M	351	13.8
N	394	15.5
P	432	17.0
R	ø10	ø.4

Rev B

NOTES

PX8

SANIFLO

WILDEN
A DOVER COMPANY

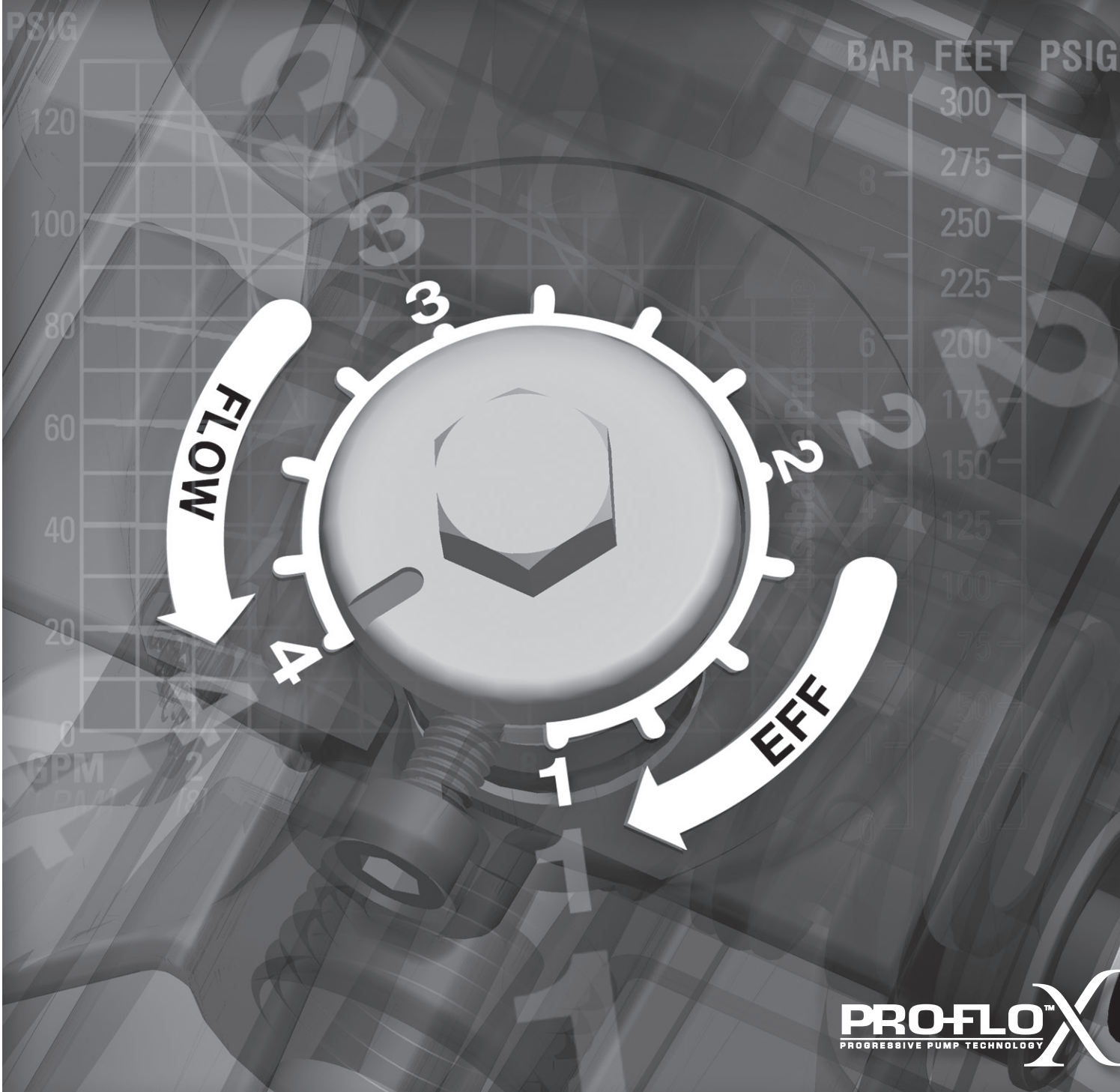

PROFLO™
PROGRESSIVE PUMP TECHNOLOGY

PX8 SANIFLO HS PERFORMANCE



Pro-Flo X™ Operating Principle

The Pro-Flo X™ air distribution system with the revolutionary Efficiency Management System (EMS) offers flexibility never before seen in the world of AODD pumps. The EMS is simple and easy to use. With the turn of an integrated control dial, the

operator can select the optimal balance of flow and efficiency that best meets the application needs. Pro-Flo X™ provides higher performance, lower operational costs and flexibility that exceeds previous industry standards.



<p>Turning the dial changes the relationship between air inlet and exhaust porting.</p>	<p>Each dial setting represents an entirely different flow curve.</p>	<p>Pro-Flo X™ pumps are shipped from the factory on setting 4, which is the highest flow rate setting possible.</p>	<p>Moving the dial from setting 4 causes a decrease in flow and an even greater decrease in air consumption.</p>	<p>When the air consumption decreases more than the flow rate, efficiency is improved and operating costs are reduced.</p>

Example 1

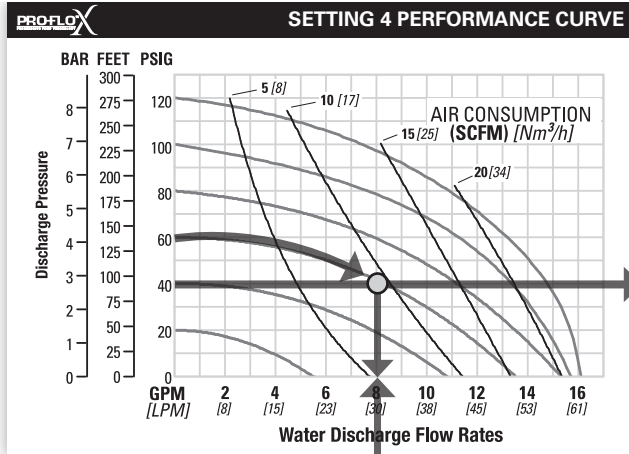

Figure 1

Example data point = **8.2** GPM

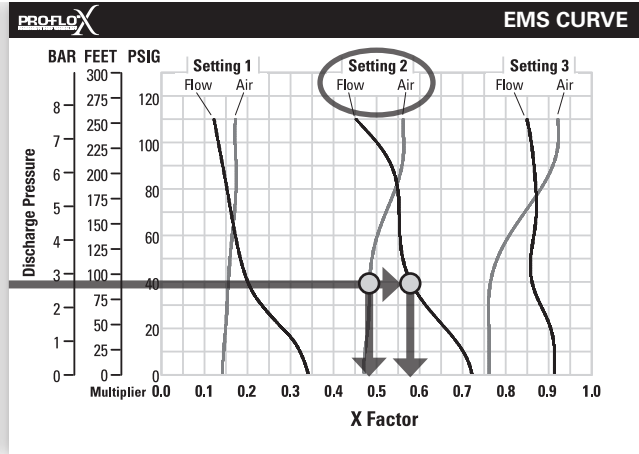

Figure 2

Example data point = **0.58** flow multiplier
0.48 air multiplier

This is an example showing how to determine flow rate and air consumption for your Pro-Flo X™ pump using the Efficiency Management System (EMS) curve and the performance curve. For this example we will be using 4.1 bar (60 psig) inlet air pressure and 2.8 bar (40 psig) discharge pressure and EMS setting 2.

Step 1: Identifying performance at setting 4. Locate the curve that represents the flow rate of the pump with 4.1 bar (60 psig) air inlet pressure. Mark the point where this curve crosses the horizontal line representing 2.8 bar (40 psig) discharge pressure (Figure 1). After locating your performance point on the flow curve, draw a vertical line downward until reaching the bottom scale on the chart. Identify the flow rate (in this case, 8.2 gpm). Observe location of performance point relative to air consumption curves and approximate air consumption value (in this case, 9.8 scfm).

Step 2: Determining flow and air X Factors. Locate your discharge pressure (40 psig) on the vertical axis of the EMS curve (Figure 2). Follow along the 2.8 bar (40 psig) horizontal line until intersecting both flow and air curves for your desired EMS setting (in this case, setting 2). Mark the points where the EMS curves intersect the horizontal discharge pressure line. After locating your EMS points on the EMS

curve, draw vertical lines downward until reaching the bottom scale on the chart. This identifies the flow X Factor (in this case, 0.58) and air X Factor (in this case, 0.48).

Step 3: Calculating performance for specific EMS setting. Multiply the flow rate (8.2 gpm) obtained in Step 1 by the flow X Factor multiplier (0.58) in Step 2 to determine the flow rate at EMS setting 2. Multiply the air consumption (9.8 scfm) obtained in Step 1 by the air X Factor multiplier (0.48) in Step 2 to determine the air consumption at EMS setting 2 (Figure 3).

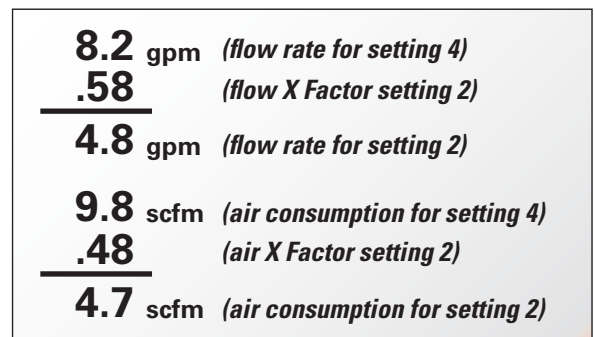

Figure 3

The flow rate and air consumption at Setting 2 are found to be 18.2 lpm (4.8 gpm) and 7.9 Nm³/h (4.7 scfm) respectively.

Example 2.1

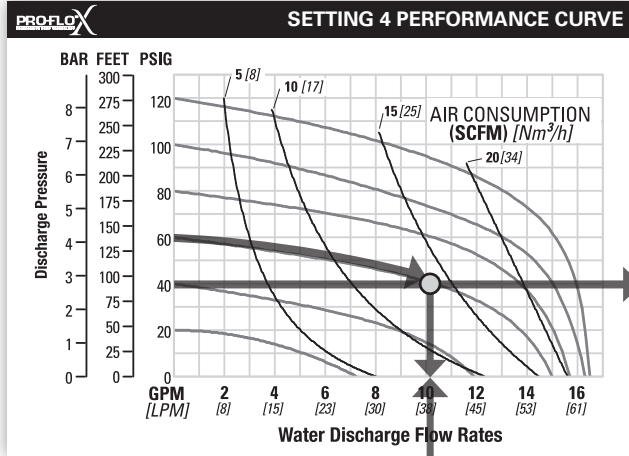

Figure 4

Example data point = 10.2 gpm

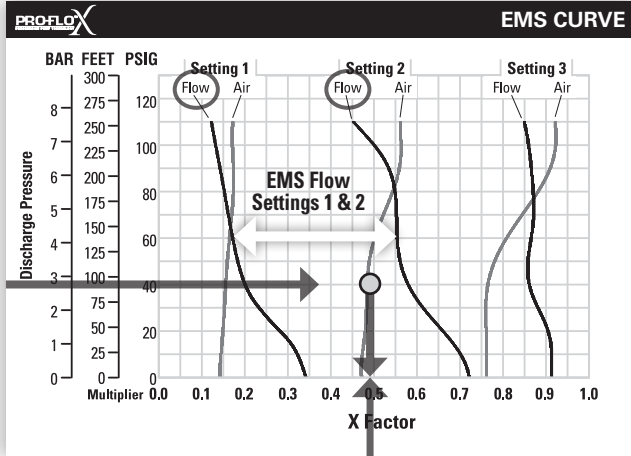

Figure 5

0.49 flow multiplier

This is an example showing how to determine the inlet air pressure and the EMS setting for your Pro-Flo X™ pump to optimize the pump for a specific application. For this example we will be using an application requirement of 18.9 lpm (5 gpm) flow rate against 2.8 bar (40 psig) discharge pressure. This example will illustrate how to calculate the air consumption that could be expected at this operational point.

DETERMINE EMS SETTING

Step 1: Establish inlet air pressure. Higher air pressures will typically allow the pump to run more efficiently, however, available plant air pressure can vary greatly. If an operating pressure of 6.9 bar (100 psig) is chosen when plant air frequently dips to 6.2 bar (90 psig) pump performance will vary. Choose an operating pressure that is within your compressed air system's capabilities. For this example we will choose 4.1 bar (60 psig).

Step 2: Determine performance point at setting 4. For this example an inlet air pressure of 4.1 bar (60 psig) inlet air pressure has been chosen. Locate the curve that represents the performance of the pump with 4.1 bar (60 psig) inlet air pressure. Mark the point where this curve crosses the horizontal line representing 2.8 bar (40 psig) discharge pressure. After locating this point on the flow curve, draw a vertical line downward until reaching the bottom scale on the chart and identify the flow rate.

In our example it is 38.6 lpm (10.2 gpm). This is the setting 4 flow rate. Observe the location of the performance point relative to air consumption curves and approximate air consumption value. In our example setting 4 air consumption is 24 Nm³/h (14 scfm). (See Figure 4.)

Step 3: Determine flow X Factor. Divide the required flow rate 18.9 lpm (5 gpm) by the setting 4 flow rate 38.6 lpm (10.2 gpm) to determine the flow X Factor for the application.

$$5 \text{ gpm} / 10.2 \text{ gpm} = 0.49 \text{ (flow X Factor)}$$

Step 4: Determine EMS setting from the flow X Factor. Plot the point representing the flow X Factor (0.49) and the application discharge pressure 2.8 bar (40 psig) on the EMS curve. This is done by following the horizontal 2.8 bar (40 psig) discharge pressure line until it crosses the vertical 0.49 X Factor line. Typically, this point lies between two flow EMS setting curves (in this case, the point lies between the flow curves for EMS setting 1 and 2). Observe the location of the point relative to the two curves it lies between and approximate the EMS setting (Figure 5). For more precise results you can mathematically interpolate between the two curves to determine the optimal EMS setting.

For this example the EMS setting is 1.8.

Example 2.2

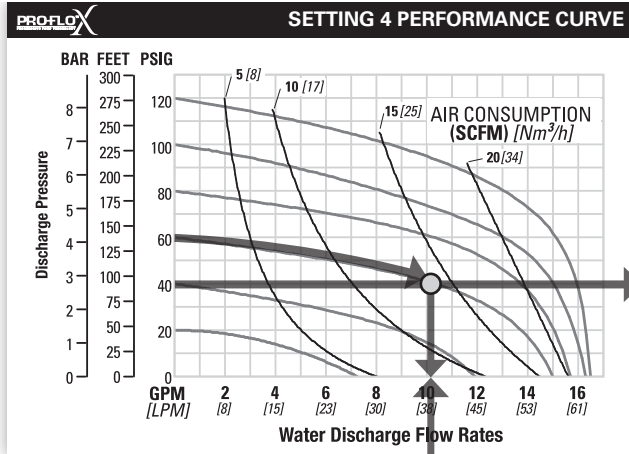

Figure 6

Example data point = **10.2** gpm

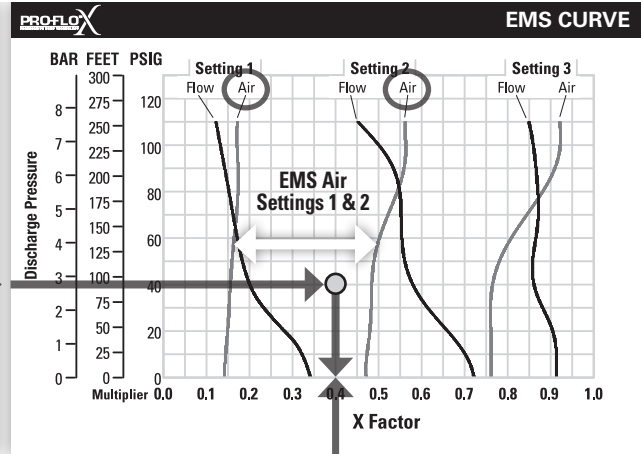

Figure 7

Example data point = **0.40** air multiplier

Determine air consumption at a specific EMS setting.

Step 1: Determine air X Factor. In order to determine the air X Factor, identify the two air EMS setting curves closest to the EMS setting established in example 2.1 (in this case, the point lies between the air curves for EMS setting 1 and 2). The point representing your EMS setting (1.8) must be approximated and plotted on the EMS curve along the horizontal line representing your discharge pressure (in this case, 40 psig). This air point is different than the flow point plotted in example 2.1. After estimating (or interpolating) this point on the curve, draw a vertical line downward until reaching the bottom scale on the chart and identify the air X Factor (Figure 7).

For this example the air X Factor is **0.40**.

Step 2: Determine air consumption. Multiply your setting 4 air consumption (14 scfm) value by the air X Factor obtained above (0.40) to determine your actual air consumption.

$$14 \text{ scfm} \times 0.40 = 5.6 \text{ SCFM}$$

In summary, for an application requiring 18.9 lpm (5 gpm) against 2.8 bar (40 psig) discharge pressure, the pump inlet air pressure should be set to 4.1 bar (60 psig) and the EMS dial should be set to 1.8. The pump would then consume 9.5 Nm³/h (5.6 scfm) of compressed air.

PX8 SANIFLO™ HS FULL-STROKE RUBBER-FITTED



PERFORMANCE



SETTING 4 PERFORMANCE CURVE

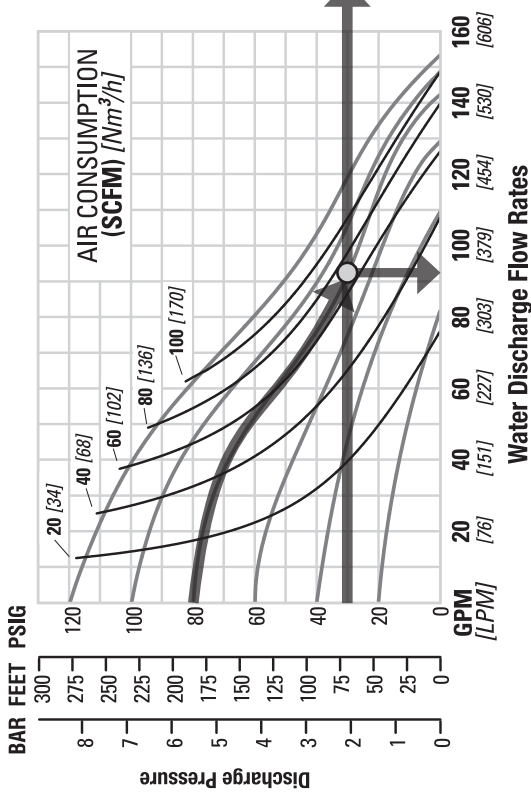

EMS CURVE

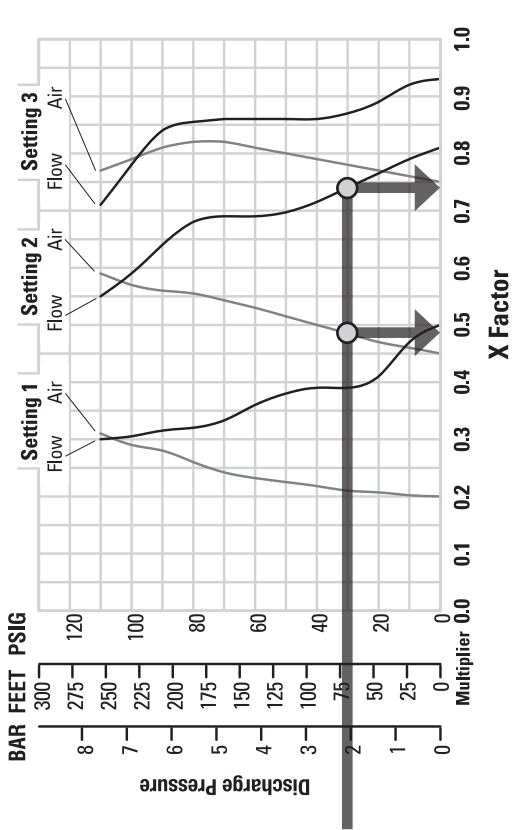

TECHNICAL DATA

Height	1,008 mm (39.7")
Width	460 mm (18.1")
Depth	498 mm (19.6")
Ship Weight	49 kg (109 lb)
Air Inlet	19 mm (3/4")
Inlet	51 mm (2")
Outlet	51 mm (2")
Suction Lift	5.3 m Dry (17.3') 9.0 m Wet (29.5')
Disp. Per Stroke	1.1 L (0.28 gal)
Max. Flow Rate	579 lpm (153 gpm)
Max. Size Solids	
Mushroom Valve	6.4 mm (1/4")
Ball Valve	12.7 mm (1/2")
Flap Valve (compressible solids)	47.5 mm (1-7/8")
Surface Finish	Ra 0.8 µm (32 µ-in)

¹Displacement per stroke was calculated at 4.8 bar (70 psig) air inlet pressure against a 2.1 bar (30 psig) head pressure.

Flow rates indicated on chart were determined by pumping water with a vertically-mounted, center-ported ball check configuration. When alternate check valve options are used, multiply flow rate by appropriate factor. Flap check valve = 83%. For optimum life and performance, pumps should be specified so that daily operation parameters fall in the center of the pump's performance curve.

The Efficiency Management System (EMS) can be used to optimize the performance of your Wilden pump for specific applications. The pump is delivered with the EMS adjusted to setting 4, which allows maximum flow.

The EMS curve allows the pump user to determine flow and air consumption at each EMS setting. For any EMS setting and discharge pressure, the X factor is used as a multiplier with the original values from the setting 4 performance curve to calculate the actual flow and air consumption values for that specific EMS setting. NOTE: You can interpolate between the setting curves for operation at intermediate EMS settings

EXAMPLE

A PX8 Saniflo™ HS, full-stroke rubber-fitted pump operating at EMS setting 4 achieved a flow rate of 348 lpm (92 gpm) using 119 Nm³/h (70 scfm) of air when run at 5.5 bar (80 psig) air inlet pressure and 2.1 bar (30 psig) discharge pressure (see dot on performance curve).

The end user did not require that much flow and wanted to reduce air consumption at his facility. He determined that EMS setting 2 would meet his needs. At 2.1 bar (30 psig) discharge pressure and EMS setting 2, the flow X factor is 0.74 and the air X factor is 0.48 (see dots on EMS curve).

Multiplying the original setting 4 values by the X factors provides the setting 2 flow rate of 258 lpm (68 gpm) and an air consumption of 57 Nm³/h (34 scfm). The flow rate was reduced by 26% while the air consumption was reduced by 52%, thus providing increased efficiency.

For a detailed example for how to set your EMS, see beginning of performance curve section.

CAUTION: Do not exceed 8.6 bar (125 psig) air supply pressure.

PX8 SANIFLO™ HS FULL-STROKE TPE-FITTED

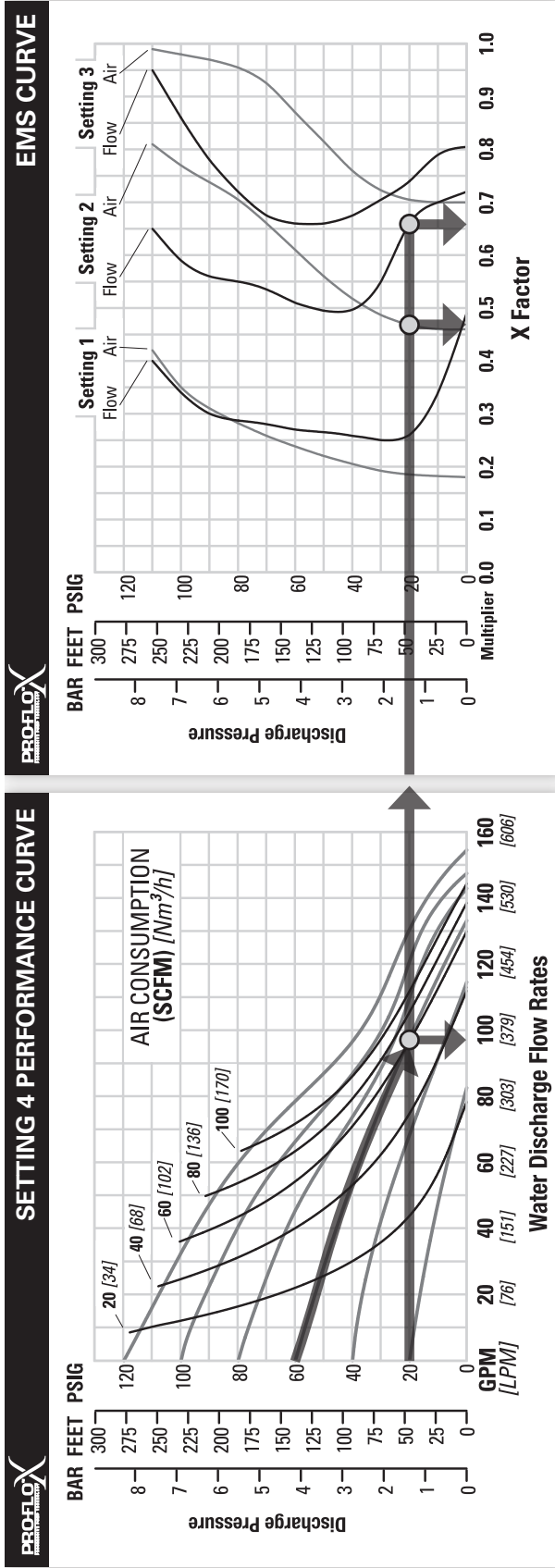

EMS CURVE

SETTING 4 PERFORMANCE CURVE

TECHNICAL DATA

Height	1,008 mm (39.7")
Width	460 mm (18.1")
Depth	498 mm (19.6")
Ship Weight	49 kg (109 lb)
Air Inlet	19 mm (3/4")
Inlet	51 mm (2")
Outlet	51 mm (2")
Suction Lift	1.9 m Dry (6.2') 9.0 m Wet (29.5')
Disp. Per Stroke	1.2 L (0.33 gal) ¹ 587 lpm (155 gpm)
Max. Flow Rate	
Max. Size Solids	
Mushroom Valve	6.4 mm (1/4")
Ball Valve	12.7 mm (1/2")
Flap Valve (compressible solids)	47.5 mm (1-7/8")
Surface Finish	Ra 0.8 µm (32 µ-in)

¹Displacement per stroke was calculated at 4.8 bar (70 psig) air inlet pressure against a 2.1 bar (30 psig) head pressure.

Flow rates indicated on chart were determined by pumping water with a vertically-mounted, center-parted ball check configuration. When alternate check valve options are used, multiply flow rate by appropriate factor. Flap check valve = 83%. For optimum life and performance, pumps should be specified so that daily operation parameters fall in the center of the pump's performance curve.

EXAMPLE

A PX8 Saniflo™ HS, full-stroke TPE-fitted pump operating at EMS setting 4 achieved a flow rate of 367 lpm (97 gpm) using 102 Nm³/h (60 scfm) of air when run at 4.1 bar (60 psig) air inlet pressure and 1.4 bar (20 psig) discharge pressure (see dot on performance curve).

The end user did not require that much flow and wanted to reduce air consumption at his facility. He determined that EMS setting 2 would meet his needs. At 1.4 bar (20 psig) discharge pressure and EMS setting 2, the flow X factor is 0.66 and the air X factor is 0.47 (see dots on EMS curve).

Multiplying the original setting 4 values by the X factors provides the setting 2 flow rate of 242 lpm (64 gpm) and an air consumption of 48 Nm³/h (28 scfm). The flow rate was reduced by 34% while the air consumption was reduced by 53%, thus providing increased efficiency.

For a detailed example for how to set your EMS, see beginning of performance curve section.

CAUTION: Do not exceed 8.6 bar (125 psig) air supply pressure.

PX8 SANIFLO™ HS FULL-STROKE PTFE-FITTED



PERFORMANCE



SETTING 4 PERFORMANCE CURVE

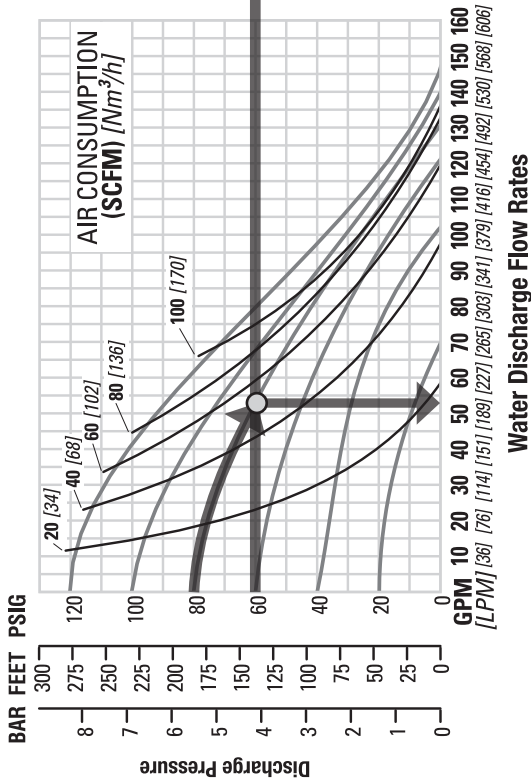

EMS CURVE

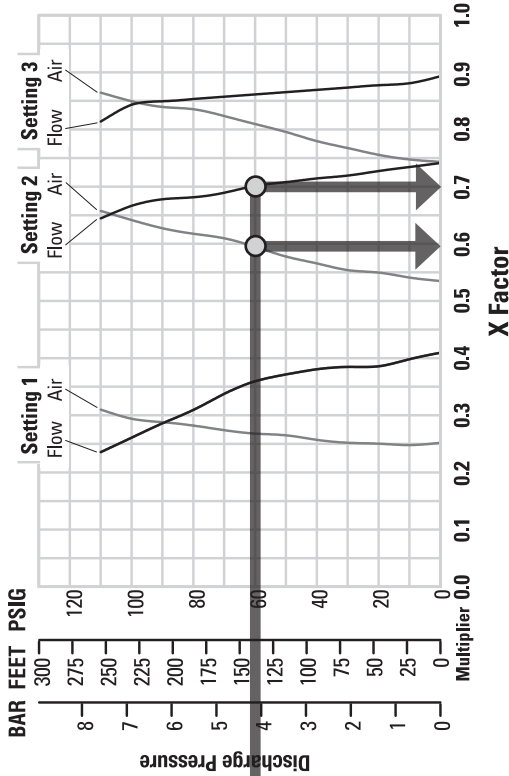

TECHNICAL DATA

Height	1,008 mm (39.7")
Width	460 mm (18.1")
Depth	398 mm (15.7")
Ship Weight	49 kg (109 lb)
Air Inlet	19 mm (3/4")
Inlet	51 mm (2")
Outlet	51 mm (2")
Suction Lift	4.8 m Dry (15.9') 8.6 m Wet (28.4')
Disp. Per Stroke	1.1 L (0.28 gal) ¹
Max. Flow Rate	.556 lpm (147 gpm)
Max. Size Solids	
Mushroom Valve	.64 mm (1/4")
Ball Valve	12.7 mm (1/2")
Surface Finish	Ra 0.8 µm (32 µ-in)

¹Displacement per stroke was calculated at 4.8 bar (70 psig) air inlet pressure against a 2.1 bar (30 psig) head pressure.

Flow rates indicated on chart were determined by pumping water with a vertically-mounted, center-ported ball check configuration. When alternate check valve options are used, multiply flow rate by appropriate factor. For optimum life and performance, pumps should be specified so that daily operation parameters fall in the center of the pump's performance curve.

The Efficiency Management System (EMS) can be used to optimize the performance of your Wilden pump for specific applications. The pump is delivered with the EMS adjusted to setting 4, which allows maximum flow.

The EMS curve allows the pump user to determine flow and air consumption at each EMS setting. For any EMS setting and discharge pressure, the X factor is used as a multiplier with the original values from the setting 4 performance curve to calculate the actual flow and air consumption values for that specific EMS setting. NOTE: You can interpolate between the setting curves for operation at intermediate EMS settings.

EXAMPLE

A PX8 Saniflo™ HS, full-stroke PTFE-fitted pump operating at EMS setting 4 achieved a flow rate of 201 lpm (53 gpm) using 93 Nm^3/h (55 scfm) of air when run at 5.5 bar (80 psig) air inlet pressure and 4.1 bar (60 psig) discharge pressure (see dot on performance curve).

The end user did not require that much flow and wanted to reduce air consumption at his facility. He determined that EMS setting 2 would meet his needs. At 4.1 bar (60 psig) discharge pressure and EMS setting 2, the flow X factor is 0.70 and the air X factor is 0.60 (see dots on EMS curve).

Multiplying the original setting 4 values by the X factors provides the setting 2 flow rate of 140 lpm (37 gpm) and an air consumption of 56 Nm^3/h (33 scfm). The flow rate was reduced by 30% while the air consumption was reduced by 40%, thus providing increased efficiency.

For a detailed example for how to set your EMS, see beginning of performance curve section.

CAUTION: Do not exceed 8.6 bar (125 psig) air supply pressure.

PX8 SANIFLO™ HS FULL-STROKE INTEGRAL PISTON DIAPHRAGM-FITTED



PERFORMANCE



SETTING 4 PERFORMANCE CURVE

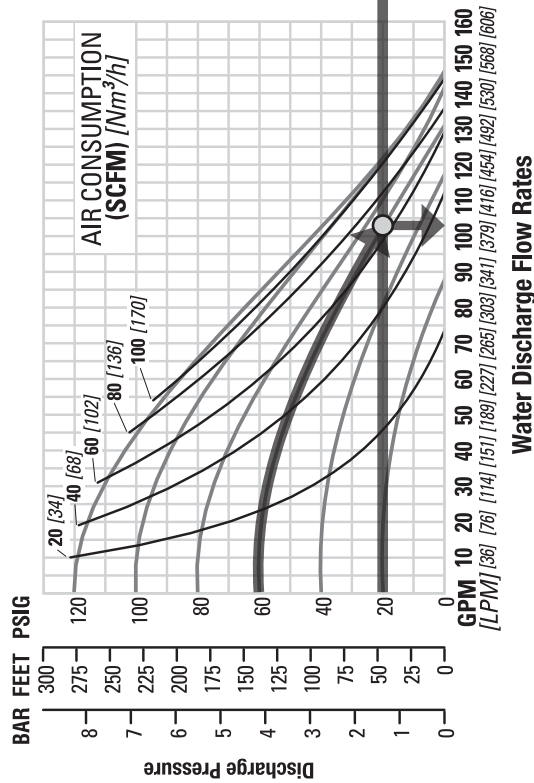

EMS CURVE

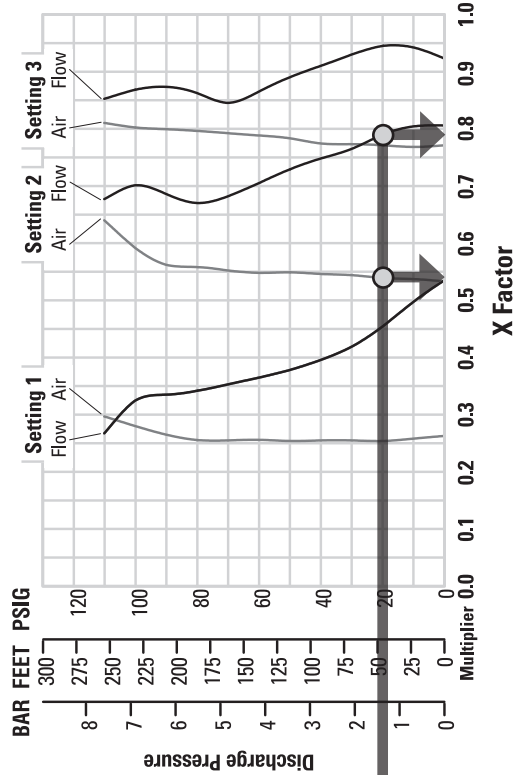

TECHNICAL DATA

Height	1,008 mm (39.7")
Width	460 mm (18.1")
Depth	398 mm (15.7")
Ship Weight	49 kg (109 lb)
Air Inlet	19 mm (3/4")
Inlet	51 mm (2")
Outlet	51 mm (2")
Suction Lift	4.7 m Dry (15.3') 8.6 m Wet (28.4')
Disp. Per Stroke	1.1 L (0.28 gal) ¹
Max. Flow Rate	556 lpm (147 gpm)
Max. Size Solids	
Mushroom Valve	6.4 mm (1/4")
Ball Valve	12.7 mm (1/2")
Surface Finish	Ra 0.8 µm (32 µin)

¹Displacement per stroke was calculated at 4.8 bar (70 psig) air inlet pressure against a 2.1 bar (30 psig) head pressure.

Flow rates indicated on chart were determined by pumping water with a vertically-mounted, center-ported ball check configuration. When alternate check valve options are used, multiply flow rate by appropriate factor. For optimum life and performance, pumps should be specified so that daily operation parameters fall in the center of the pump's performance curve.

EXAMPLE

A PX8 Saniflo™ HS, full-stroke IPD-fitted pump operating at EMS setting 4 achieved a flow rate of 390 lpm (103 gpm) using 105 Nm³/h (62 scfm) of air when run at 4.1 bar (60 psig) air inlet pressure and 1.4 bar (20 psig) discharge pressure (see dot on performance curve).

The end user did not require that much flow and wanted to reduce air consumption at his facility. He determined that EMS setting 2 would meet his needs. At 1.4 bar (20 psig) discharge pressure and EMS setting 2, the flow X factor is 0.79 and the air X factor is 0.54 (see dots on EMS curve).

Multiplying the original setting 4 values by the X factors provides the setting 2 flow rate of 308 lpm (81 gpm) and an air consumption of 57 Nm³/h (33 scfm). The flow rate was reduced by 21% while the air consumption was reduced by 46%, thus providing increased efficiency.

For a detailed example for how to set your EMS, see beginning of performance curve section.

CAUTION: Do not exceed 8.6 bar (125 psig) air supply pressure.

PX8 SANIFLO™ HS REDUCED-STROKE PTFE-FITTED



PERFORMANCE



SETTING 4 PERFORMANCE CURVE

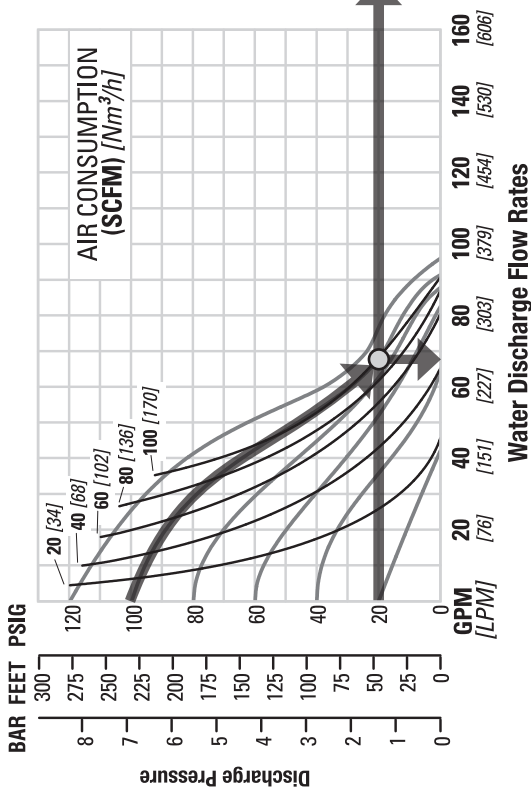

EMS CURVE

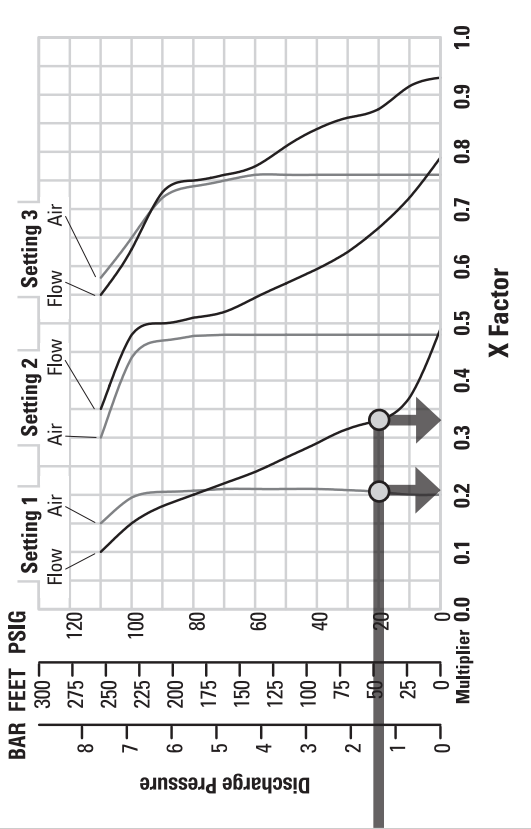

TECHNICAL DATA

Height	1,008 mm (39.7")
Width	460 mm (18.1")
Depth	498 mm (19.6")
Ship Weight	49 kg (109 lb)
Air Inlet	19 mm (3/4")
Inlet	51 mm (2")
Outlet	51 mm (2")
Suction Lift	2.8 m Dry (9.1') 9.0 m Wet (29.5')
Disp. Per Stroke	0.5 L (0.13 gal)
Max. Flow Rate	363 lpm (96 gpm)
Max. Size Solids	
Mushroom Valve	6.4 mm (1/4")
Ball Valve	12.7 mm (1/2")
Surface Finish	Ra 0.8 µm (32 µin)

¹Displacement per stroke was calculated at 4.8 bar (70 psig) air inlet pressure against a 2.1 bar (30 psig) head pressure.

Flow rates indicated on chart were determined by pumping water with a vertically-mounted, center-ported ball check configuration. When alternate check valve options are used, multiply flow rate by appropriate factor. For optimum life and performance, pumps should be specified so that daily operation parameters fall in the center of the pump's performance curve.

The Efficiency Management System (EMS) can be used to optimize the performance of your Wilden pump for specific applications. The pump is delivered with the EMS adjusted to setting 4, which allows maximum flow.

The EMS curve allows the pump user to determine flow and air consumption at each EMS setting. For any EMS setting and discharge pressure, the X factor is used as a multiplier with the original values from the setting 4 performance curve to calculate the actual flow and air consumption values for that specific EMS setting. NOTE: You can interpolate between the setting curves for operation at intermediate EMS settings.

EXAMPLE

A PX8 Saniflo™ HS, reduced-stroke PTFE-fitted pump operating at EMS setting 4 achieved a flow rate of 257 lpm (68 gpm) using 170 Nm³/h (100 scfm) of air when run at 6.9 bar (100 psig) air inlet pressure and 1.4 bar (20 psig) discharge pressure (see dot on performance curve).

The end user did not require that much flow and wanted to reduce air consumption at his facility. He determined that EMS setting 1 would meet his needs. At 1.4 bar (20 psig) discharge pressure and EMS setting 1, the flow X factor is 0.33 and the air X factor is 0.21 (see dots on EMS curve).

Multiplying the original setting 4 values by the X factors provides the setting 1 flow rate of 85 lpm (22 gpm) and an air consumption of 36 Nm³/h (21 scfm). The flow rate was reduced by 67% while the air consumption was reduced by 79%, thus providing increased efficiency.

For a detailed example for how to set your EMS, see beginning of performance curve section.

CAUTION: Do not exceed 8.6 bar (125 psig) air supply pressure.

PX8 SANIFLO™ HS REDUCED-STROKE PTFE INTEGRAL PISTON DIAPHRAGM-FITTED

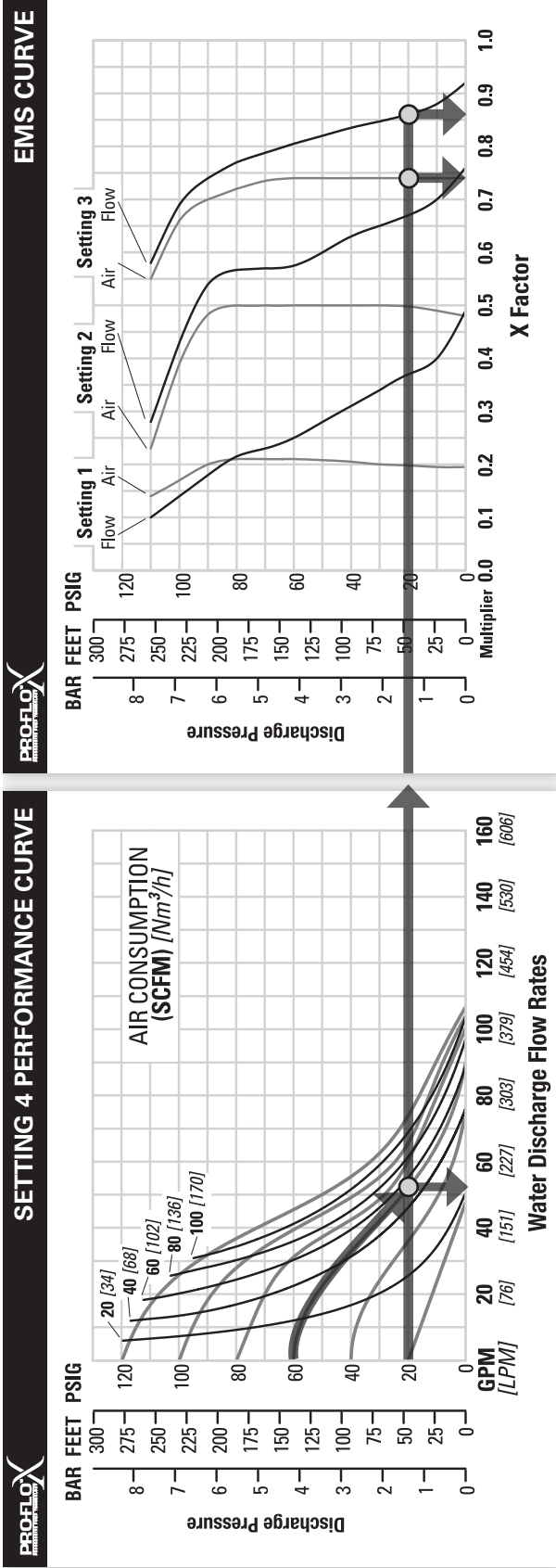

TECHNICAL DATA

Height	1,008 mm (39.7")
Width	460 mm (18.1")
Depth	498 mm (19.6")
Ship Weight	49 kg (109 lb)
Air Inlet	19 mm (3/4")
Inlet	51 mm (2")
Outlet	51 mm (2")
Suction Lift	2.3 m Dry (7.4') 9.0 m Wet (29.5')
Disp. Per Stroke	0.4 L (0.11 gal)
Max. Flow Rate	405 lpm (107 gpm)
Max. Size Solids	
Mushroom Valve	6.4 mm (1/4")
Ball Valve	12.7 mm (1/2")
Surface Finish	Ra 0.8 µm (32 µ-in)

¹Displacement per stroke was calculated at 4.8 bar (70 psig) air inlet pressure against a 2.1 bar (30 psig) head pressure.

Flow rates indicated on chart were determined by pumping water with a vertically-mounted, center-ported ball check configuration. When alternate check valve options are used, multiply flow rate by appropriate factor. For optimum life and performance, pumps should be specified so that daily operation parameters fall in the center of the pump's performance curve.

The Efficiency Management System (EMS) can be used to optimize the performance of your Wilden pump for specific applications. The pump is delivered with the EMS adjusted to setting 4, which allows maximum flow.

The EMS curve allows the pump user to determine flow and air consumption at each EMS setting. For any EMS setting and discharge pressure, the X factor is used as a multiplier with the original values from the setting 4 performance curve to calculate the actual flow and air consumption values for that specific EMS setting. NOTE: You can interpolate between the setting curves for operation at intermediate EMS settings.

EXAMPLE

A PX8 Saniflo™ HS, reduced-stroke PTFE IPD-fitted pump operating at EMS setting 4 achieved a flow rate of 197 lpm (52 gpm) using 93 Nm³/h (55 scfm) of air when run at 4.1 bar (60 psig) air inlet pressure and 1.4 bar (20 psig) discharge pressure (see dot on performance curve).

The end user did not require that much flow and wanted to reduce air consumption at his facility. He determined that EMS setting 3 would meet his needs. At 1.4 bar (20 psig) discharge pressure and EMS setting 3, the flow X factor is 0.87 and the air X factor is 0.74 (see dots on EMS curve).

Multiplying the original setting 4 values by the X factors provides the setting 3 flow rate of 171 lpm (45 gpm) and an air consumption of 69 Nm³/h (41 scfm). The flow rate was reduced by 13% while the air consumption was reduced by 26%, thus providing increased efficiency.

For a detailed example for how to set your EMS, see beginning of performance curve section.

CAUTION: Do not exceed 8.6 bar (125 psig) air supply pressure.

PX8 SANIFLO™ HS REDUCED-STROKE ULTRA-FLEX™-FITTED



PERFORMANCE



SETTING 4 PERFORMANCE CURVE

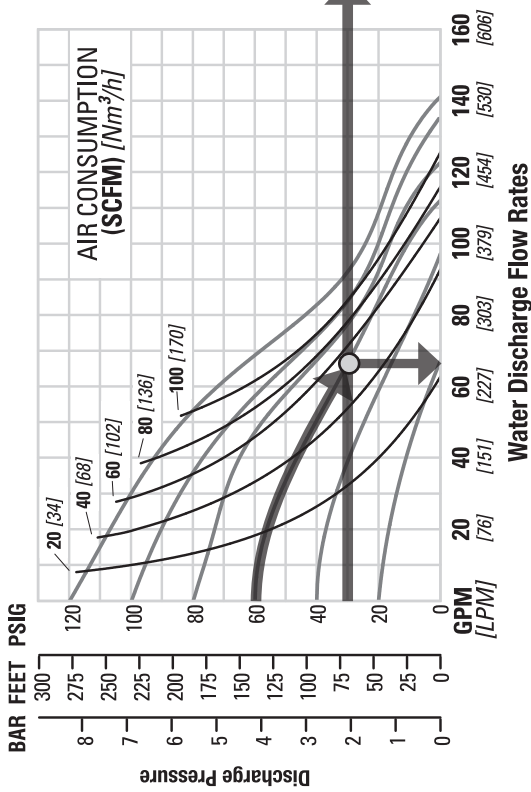

EMS CURVE

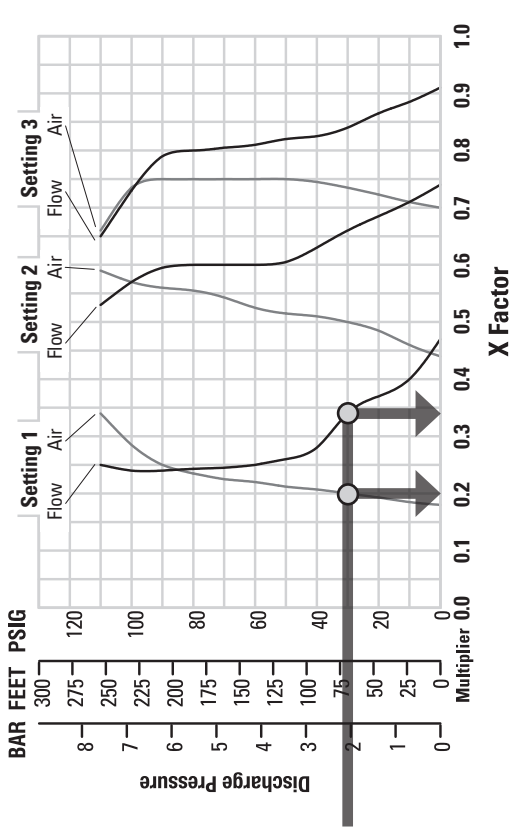

TECHNICAL DATA

Height	1,008 mm (39.7")
Width	460 mm (18.1")
Depth	498 mm (19.6")
Ship Weight	49 kg (109 lb)
Air Inlet	19 mm (3/4")
Inlet	51 mm (2")
Outlet	51 mm (2")
Suction Lift	3.8 m Dry (12.5') 9.0 m Wet (29.5')
Disp. Per Stroke	0.9 L (0.23 gal) ¹
Max. Flow Rate	534 lpm (141 gpm)
Max. Size Solids	
Mushroom Valve	6.4 mm (1/4")
Ball Valve	12.7 mm (1/2")
Surface Finish	Ra 0.8 µm (32 µ-in)

¹Displacement per stroke was calculated at 4.8 bar (70 psig) air inlet pressure against a 2.1 bar (30 psig) head pressure.

Flow rates indicated on chart were determined by pumping water with a vertically-mounted, center-ported ball check configuration. When alternate check valve options are used, multiply flow rate by appropriate factor. For optimum life and performance, pumps should be specified so that daily operation parameters fall in the center of the pump's performance curve.

The Efficiency Management System (EMS) can be used to optimize the performance of your Wilden pump for specific applications. The pump is delivered with the EMS adjusted to setting 4, which allows maximum flow.

The EMS curve allows the pump user to determine flow and air consumption at each EMS setting. For any EMS setting and discharge pressure, the X factor is used as a multiplier with the original values from the setting 4 performance curve to calculate the actual flow and air consumption values for that specific EMS setting. NOTE: You can interpolate between the setting curves for operation at intermediate EMS settings.

EXAMPLE

A PX8 Saniflo™ HS, reduced-stroke Ultra-Flex™-fitted pump operating at EMS setting 4 achieved a flow rate of 250 lpm (66 gpm) using 97 Nm³/h (57 scfm) of air when run at 4.1 bar (60 psig) air inlet pressure and 2.1 bar (30 psig) discharge pressure (see dot on performance curve).

The end user did not require that much flow and wanted to reduce air consumption at his facility. He determined that EMS setting 1 would meet his needs. At 2.1 bar (30 psig) discharge pressure and EMS setting 1, the flow X factor is 0.34 and the air X factor is 0.20 (see dots on EMS curve).

Multiplying the original setting 4 values by the X factors provides the setting 1 flow rate of 85 lpm (22 gpm) and an air consumption of 19 Nm³/h (11 scfm). The flow rate was reduced by 66% while the air consumption was reduced by 80%, thus providing increased efficiency.

For a detailed example for how to set your EMS, see beginning of performance curve section.

CAUTION: Do not exceed 8.6 bar (125 psig) air supply pressure.



SUCTION-LIFT CURVES

PX8 SANIFLO™ HS
REDUCED-STROKE
SUCTION-LIFT CAPABILITY

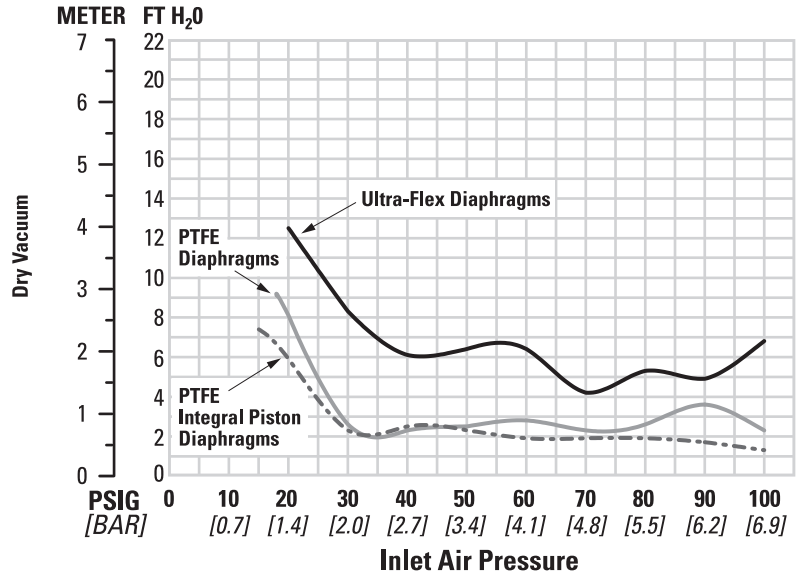

PX8 SANIFLO™ HS FULL-STROKE
SUCTION-LIFT CAPABILITY

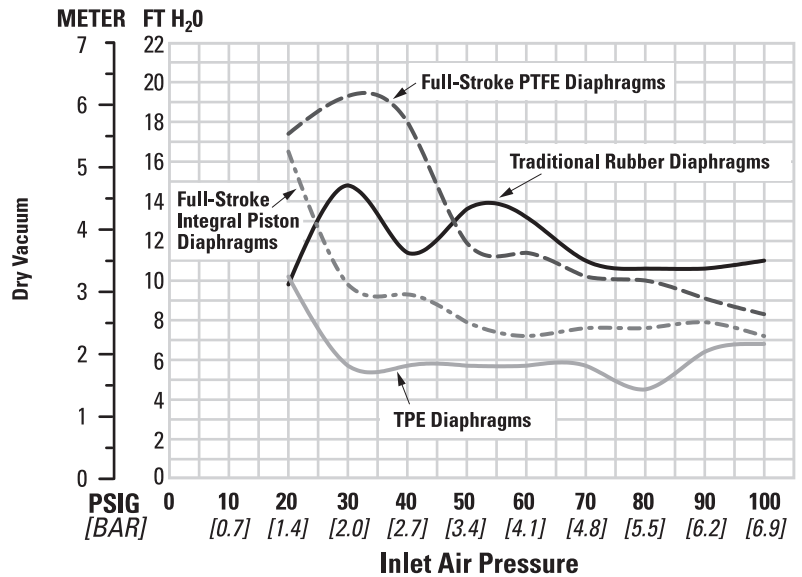

Suction-lift curves are calibrated for pumps operating at 305 m (1,000') above sea level. This chart is meant to be a guide only. There are many variables that can affect your pump's operating characteristics. The

number of intake and discharge elbows, viscosity of pumping fluid, elevation (atmospheric pressure) and pipe friction loss all affect the amount of suction lift your pump will attain.

NOTES

SUGGESTED INSTALLATION

Wilden pumps are designed to meet the performance requirements of even the most demanding pumping applications. They have been designed and manufactured to the highest standards and are available in a variety of liquid-path materials to meet your chemical-resistance needs. Refer to the performance section of this manual for an in-depth analysis of the performance characteristics of your pump. Wilden offers the widest variety of elastomer options in the industry to satisfy temperature, chemical-compatibility, abrasion-resistance and flex concerns.

The suction pipe size should be equivalent or larger than the diameter of the suction inlet on your Wilden pump. The suction hose must be non-collapsible, reinforced type as these pumps are capable of pulling a high vacuum. Discharge piping should also be equivalent or larger than the diameter of the pump discharge to minimize friction losses. It is critical that all fittings and connections are airtight or a reduction or loss of pump suction capability will result.

INSTALLATION: Months of careful planning, study and selection efforts can result in unsatisfactory pump performance if installation details are left to chance.

Premature failure and long-term dissatisfaction can be avoided if reasonable care is exercised throughout the installation process.

LOCATION: Noise, safety and other logistical factors usually dictate where equipment will be situated on the production floor. Multiple installations with conflicting requirements can result in congestion of utility areas, leaving few choices for additional pumps.

Within the framework of these and other existing conditions, every pump should be located in such a way that the following key factors are balanced against each other to maximum advantage.

ACCESS: First of all, the location should be accessible. If it is easy to reach the pump, maintenance personnel will have an easier time carrying out routine inspections and adjustments. Should major repairs become necessary, ease of access can play a key role in speeding the repair process and reducing total downtime.

AIR SUPPLY: Every pump location should have an air line large enough to supply the volume of air necessary to achieve the desired pumping rate. Do not exceed the maximum rated air pressure.

For best results, the pumps should use a 5 μ (micron) air filter, needle valve and regulator. The use of an air filter before the pump will ensure that the majority of any pipeline contaminants will be eliminated.

SOLENOID OPERATION: When operation is controlled by a solenoid valve in the air line, three-way valves should be used. This valve allows trapped air between the valve and the pump to bleed off which improves pump performance.

MUFFLER: Sound levels are reduced below OSHA specifications using the standard Wilden muffler. Other mufflers can be used to further reduce sound levels, but they usually reduce pump performance.

ELEVATION: Selecting a site that is well within the pump's dynamic-lift capability will ensure that loss-of-prime issues will be eliminated. In addition, pump efficiency can be adversely affected if proper attention is not given to site location.

PIPING: Final determination of the pump site should not be made until the piping challenges of each possible location have been evaluated. The impact of current and future installations should be considered ahead of time to make sure that inadvertent restrictions are not created for any remaining sites.

The best choice possible will be a site involving the shortest and straightest hookup of suction and discharge piping. Unnecessary elbows, bends and fittings should be avoided. Pipe sizes should be selected to keep friction losses within practical limits. All piping should be supported independently of the pump. In addition, the piping should be aligned to avoid placing stress on the pump fittings.

Flexible hose can be installed to aid in absorbing the forces created by the natural reciprocating action of the pump. If the pump is to be bolted down to a solid location, a mounting pad placed between the pump and the foundation will assist in minimizing pump vibration. Flexible connections between the pump and rigid piping will also assist in minimizing pump vibration. If quick-closing valves are installed at any point in the discharge system, or if pulsation within a system becomes a problem, a surge suppressor (SD Equalizer®) should be installed to protect the pump, piping and gauges from surges and water hammer.

If the pump is to be used in a self-priming application, make sure that all connections are airtight and that the suction lift is within the model's capability. **NOTE:** Materials of construction and elastomer options have an effect on suction-lift parameters. Please refer to the performance section for specifics.

When pumps are installed in applications involving flooded suction or suction head pressures, a gate valve should be installed in the suction line to permit closing of the line for pump service.

Pumps in service with a positive suction head are most efficient when inlet pressure is limited to 0.5–0.7 bar (7–10 psig). Premature diaphragm failure may occur if positive suction is 0.7 bar (10 psig) and higher.

SUBMERSIBLE APPLICATIONS: Pro-Flo X™ pumps can be used for submersible applications, when using the Pro-Flo X™ submersible option.

ALL WILDEN PUMPS ARE CAPABLE OF PASSING SOLIDS. A STRAINER SHOULD BE USED ON THE PUMP INTAKE TO ENSURE THAT THE PUMP'S RATED SOLIDS CAPACITY IS NOT EXCEEDED.

SUGGESTED INSTALLATION

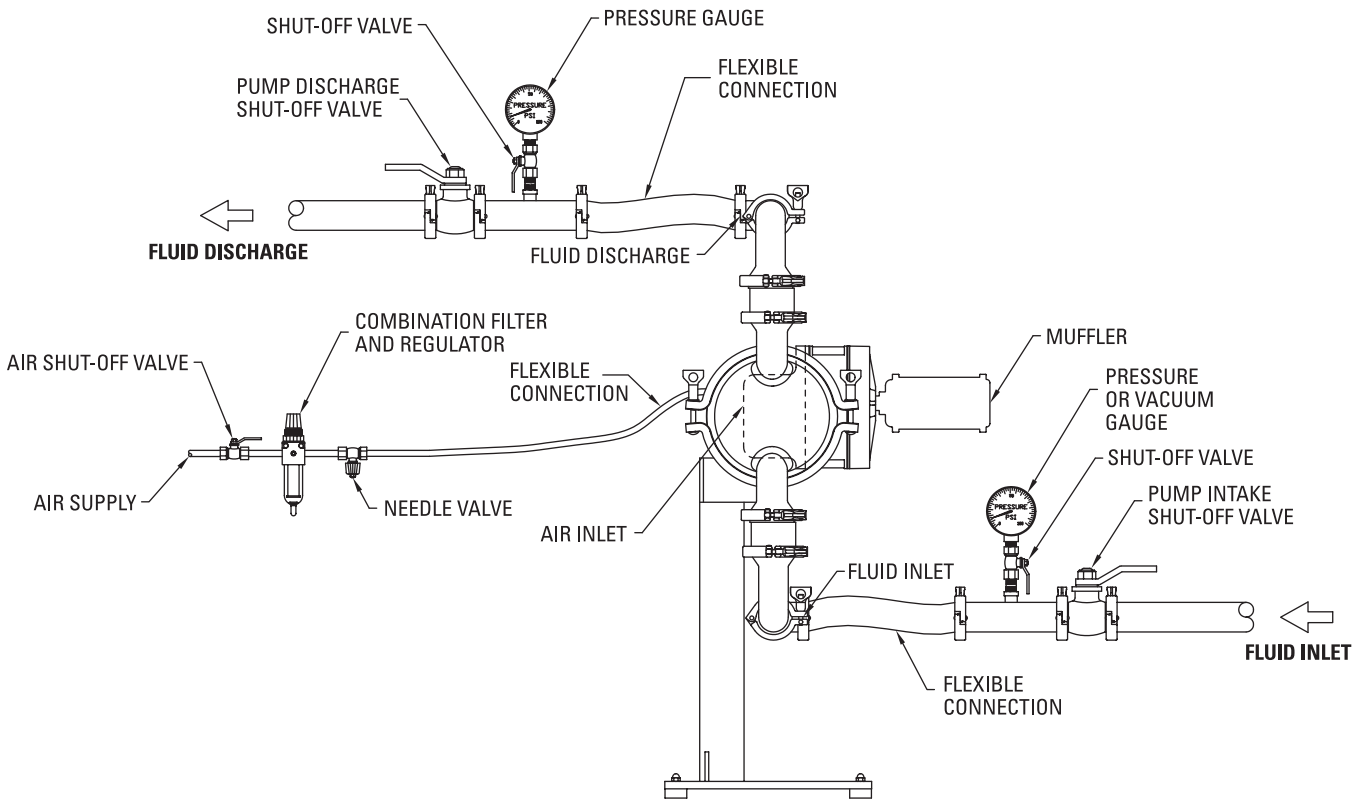

NOTE: In the event of a power failure, the air shut-off valve should be closed, if restarting of the pump is not desirable once power is regained.

AIR-OPERATED PUMPS: To stop the pump from operating in an emergency situation, simply close the air shut-off valve (user-supplied) installed in the air supply line. A properly functioning

valve will stop the air supply to the pump, therefore stopping output. This air shut-off valve should be located far enough away from the pumping equipment such that it can be reached safely in an emergency situation.

SUGGESTED OPERATION & MAINTENANCE

OPERATION: The Pro-Flo® and Pro-Flo X™ pumps are pre-lubricated and do not require in-line lubrication. Additional lubrication will not damage the pump, however if the pump is heavily lubricated by an external source, the pump's internal lubrication may be washed away. If the pump is then moved to a non-lubricated location, it may need to be disassembled and re-lubricated as described in the DISASSEMBLY/REASSEMBLY INSTRUCTIONS.

Pump-discharge rate can be controlled by limiting the volume and/or pressure of the air supply to the pump. An air regulator is used to regulate air pressure. A needle valve is used to regulate volume. Pump-discharge rate can also be controlled by throttling the pump discharge by partially closing a valve in the discharge line of the pump. This action increases friction loss which reduces flow rate. (See Section 5.) This is useful when the need exists to control the pump from a remote location. When the pump-discharge pressure equals or exceeds the air supply pressure, the pump will stop; no bypass or pressure relief valve is needed, and pump damage will not occur. The pump has reached a "deadhead" situation and can be restarted by reducing the fluid

discharge pressure or increasing the air inlet pressure. The Wilden Pro-Flo® and Pro-Flo X™ pumps run solely on compressed air and do not generate heat, therefore your process fluid temperature will not be affected.

MAINTENANCE AND INSPECTIONS: Since each application is unique, maintenance schedules may be different for every pump. Frequency of use, line pressure, viscosity and abrasiveness of process fluid all affect the parts life of a Wilden pump. Periodic inspections have been found to offer the best means for preventing unscheduled pump downtime. Personnel familiar with the pump's construction and service should be informed of any abnormalities that are detected during operation.

RECORDS: When service is required, a record should be made of all necessary repairs and replacements. Over a period of time, such records can become a valuable tool for predicting and preventing future maintenance problems and unscheduled downtime. In addition, accurate records make it possible to identify pumps that are poorly suited to their applications.

TROUBLESHOOTING

Pump will not run, or runs slowly.

1. Ensure that the air inlet pressure is at least 0.4 bar (5 psig) above startup pressure and that the differential pressure (the difference between air inlet and liquid discharge pressures) is not less than 0.7 bar (10 psig).
2. Check air inlet filter for debris (see SUGGESTED INSTALLATION).
3. Check for extreme air leakage (blow by) which would indicate worn seals/bores in the air valve, pilot spool and main shaft.
4. Disassemble pump and check for obstructions in the air passageways or objects that would obstruct the movement of internal parts.
5. Check mating surfaces of flap valve assembly.
6. Check for sticking ball check valves. If material being pumped is not compatible with pump elastomers, swelling may occur. Replace ball check valves and seats with proper elastomers. Also, as the check valve balls wear out, they become smaller and can become stuck in the seats. In this case, replace balls and seats.
7. Check for broken inner pistons which will cause the air valve spool to be unable to shift.
8. Remove plug from pilot spool exhaust.

Pump runs, but little or no product flows.

1. Check for pump cavitation; slow pump speed down to allow thick material to flow into liquid chambers.

2. Verify that vacuum required to lift liquid is not greater than the vapor pressure of the material being pumped (cavitation).
3. Check for sticking ball check valves. If material being pumped is not compatible with pump elastomers, swelling may occur. Replace ball check valves and seats with proper elastomers. Also, as the check valve balls wear out, they become smaller and can become stuck in the seats. In this case, replace balls and seats.

Pump air valve freezes.

1. Check for excessive moisture in compressed air. Either install a dryer or hot-air generator for compressed air. Alternatively, a coalescing filter may be used to remove the water from the compressed air in some applications.

Air bubbles in pump discharge.

1. Check for ruptured diaphragm.
2. Check tightness of outer pistons (refer to Section 7).
3. Check tightness of fasteners and integrity of O-rings and seals, especially at intake manifold.
4. Ensure pipe connections are airtight.

Product comes out air exhaust.

1. Check for diaphragm rupture.
2. Check tightness of outer pistons to shaft.



PUMP DISASSEMBLY

Tools Required:

- Adjustable Wrench
- Vise equipped with soft jaws (such as plywood, plastic or other suitable material)

CAUTION: Before any maintenance or repair is attempted, the compressed air line to the pump should be disconnected and all air pressure allowed to bleed from the pump. Disconnect all intake, discharge and air lines. Drain the pump by turning it upside down and allowing any fluid to flow into a suitable container. Be aware of any hazardous effects of contact with your process fluid.

NOTE: The model photographed for these instructions incorporates PTFE diaphragms.

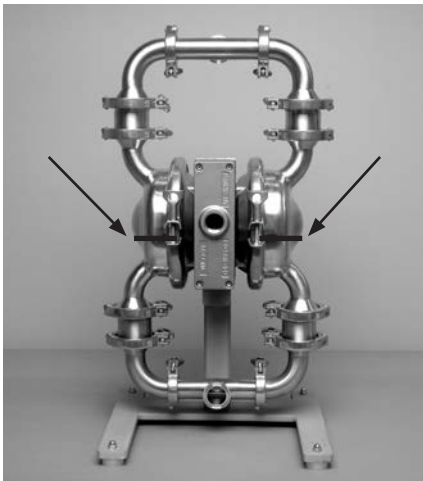

Step 1

Prior to assembly, place alignment marks on the liquid chambers and air chambers to assist with proper alignment during reassembly.



Step 2

Loosen the wing nut and remove both discharge manifold clamp bands.



Step 3

Remove the discharge manifold and manifold gaskets.



Step 4

Next, remove the clamp bands that secure the ball valve housing to the liquid chamber.



Step 5A

Next, remove the ball valve housing, valve ball and gasket.



Step 5B

If your pump is fitted with a mushroom valve, remove the mushroom valve housing, mushroom valve and gasket.



Step 6

Loosen the wing nut and remove the inlet manifold clamp bands.



Step 7

Next, remove the clamp bands that secure the ball valve housing to the liquid chamber.



Step 8

Next, remove the ball valve housing, valve ball and gasket from liquid chamber. To ensure proper alignment during reassembly of manifold/liquid chamber interface, turn off-set portion of valve housing to the left or to the right. This procedure works for the inlet manifold and discharge manifold connections.

WILDEN PUMP & ENGINEERING, LLC

WIL-GARD™ DIAPHRAGM SENSOR

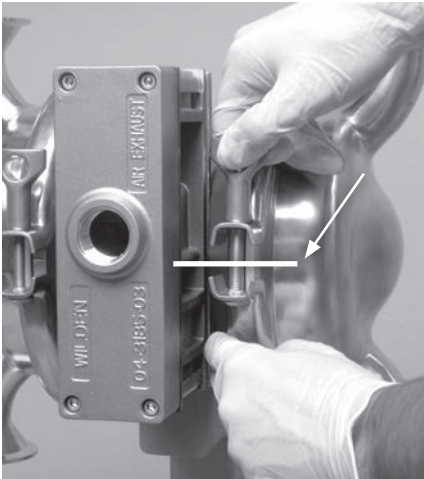

Step 9

Now the large clamp bands can be removed. **NOTE:** Prior to disassembly, alignment marks should be placed on the liquid chambers and air chambers to assist with proper alignment during reassembly.

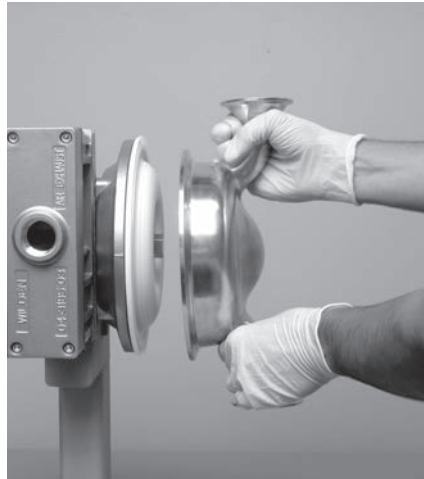

Step 10A

Next, remove the liquid chamber from the center section assembly.



Step 10B

If your pump is fitted with an integral piston diaphragm (IPD), when you remove the liquid chamber you will notice that there is no outer piston.



Step 11A

Using two (2) adjustable wrenches, turning in the opposite direction, loosen and remove one (1) of the two (2) outer pistons.



Step 11B

If your pump is fitted with an IPD, the procedure for removing the diaphragm is slightly different. In this case, simply grasp the diaphragm in two locations and turn in a counter-clockwise direction.



Step 12A

After loosening and removing the outer piston, the remaining diaphragm assembly and shaft can be removed from the center section assembly.

PUMP DISASSEMBLY



Step 12B

If your pump is fitted with an IPD, the procedure for removing the diaphragm is the same.

WIL-GARD™ DIAPHRAGM SENSOR

Wil-Gard™ Diaphragm Sensor Removal



Step 1

After removing the inlet and discharge manifold assemblies, disconnect the Wil-Gard™ module from the sensor wires.



Step 2

Next, remove the large clamp bands and the liquid chamber on either side of the pump.



Step 3

The Wil-Gard™ sensor cables can be easily removed from the diaphragm assembly by simply pulling them from between the primary and back-up diaphragm.

WIL-GARD[™] DIAPHRAGM SENSOR

Wil-Gard[™] Diaphragm Sensor Installation



Step 1

The Wil-Gard[™] sensor wires must be installed between the primary diaphragm and the back-up diaphragm, on both sides of the pump, at the six o'clock position. They should be positioned approximately half the distance to the shaft from the edge of the diaphragm.



Step 2

Prior to installing the liquid chamber, and after positioning the Wil-Gard[™] sensor cable between the primary and back-up diaphragms, run the sensor cable along the diaphragm bead but outside the pump. Now install the liquid chamber and large clamp band.



Step 3

When installing the liquid chamber and large clamp band, route the Wil-Gard[™] sensor cable to the inside of the large clamp band fastener. Next, reconnect the Wil-Gard[™] module. **NOTE:** Use caution to ensure that the sensor wires are not damaged or pinched by the clamp band.

AIR VALVE / CENTER SECTION DISASSEMBLY

Tools Required:

Tools Required:

- Appropriate-sized wrench
- Snap-Ring Pliers
- O-Ring Pick

CAUTION: Before any maintenance or repair is attempted, the compressed air line to the pump should be disconnected and all air pressure allowed to bleed from the pump. Disconnect all intake, discharge and air lines. Drain the pump by turning it upside down and allowing any fluid to flow into a suitable container. Be aware of hazardous effects of contact with your process fluid.



Step 1

Using an appropriate-sized wrench loosen the bolts that connect the center section to the stand.
CAUTION: With bolts removed, the center section is no longer attached to the stand and must be supported so that it does not fall from the stand.



Step 2

Remove the center section from the stand.



Step 3

Using an appropriate-sized hex wrench, loosen air valve bolts.

AIR VALVE / CENTER SECTION DISASSEMBLY

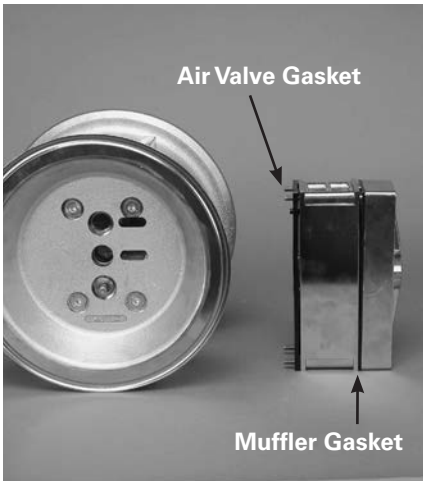

Step 4

Remove muffer plate and air valve bolts from air valve assembly exposing muffer gasket for inspection. Replace, if necessary.

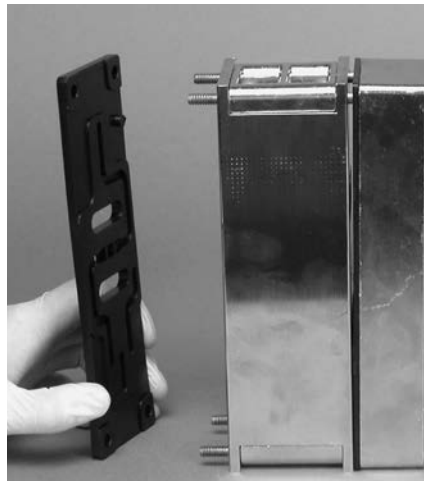

Step 5

Lift away air valve assembly and remove air valve gasket for inspection. Replace, if necessary.



Step 6

Remove air valve end cap to expose air valve spool by simply lifting up on end cap once air valve bolts are removed. **NOTE:** Pro-Flo X™ air valve incorporates an end cap at both ends of the air valve.

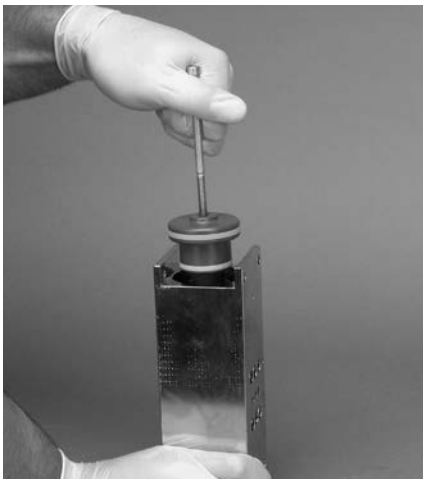

Step 7

Remove the air valve spool from the air valve body by threading one air valve bolt into the end of the air valve spool and gently sliding the spool out of the air valve body. Inspect seals for signs of wear and replace entire assembly if necessary. Use caution when handling air valve spool to prevent damaging seals. **NOTE:** Seals should not be removed from assembly. Seals are not sold separately.



Step 8

Remove pilot sleeve retaining snap-ring on both sides of center section with snap-ring pliers.



Step 9

Remove pilot spool sleeve from center section.

AIR VALVE / CENTER SECTION DISASSEMBLY

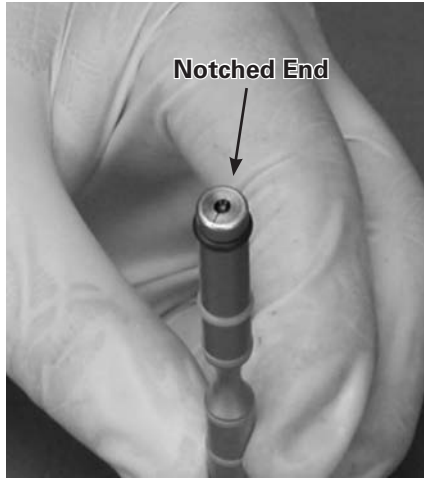

Step 10

Using an O-ring pick, gently remove the O-ring from the opposite side of the notched end on one side of the pilot spool. Gently remove the pilot spool from pilot spool sleeve and inspect for nicks, gouges and wear. Replace pilot sleeve or outer sleeve O-rings if necessary. During reassembly, never insert the pilot spool into the sleeve with the notched end first, this end incorporates the urethane O-ring and will be damaged as it slides over the ports cut in the sleeve. **NOTE:** Seals should not be removed from pilot spool. Seals are not sold separately.

REASSEMBLY HINTS & TIPS

ASSEMBLY:

Upon performing applicable maintenance to the air distribution system, the pump can now be reassembled. Please refer to the disassembly instructions for photos and parts placement. To reassemble the pump, follow the disassembly instructions in reverse order. The air distribution system needs to be assembled first, then the diaphragms and finally the wetted path. The following tips will assist in the assembly process.

- Lubricate air valve bore, center section shaft and pilot spool bore with NLGI grade 2 white EP bearing grease or equivalent.
- Clean the inside of the center section shaft bore to ensure no damage is done to new shaft seals.
- A small amount of NLGI grade 2 white EP bearing grease can be applied to the muffler and air valve gaskets to lubricate gaskets during assembly.
- Make sure that the exhaust port on the muffler plate is centered between the two exhaust ports on the center section.
- Stainless steel bolts should be lubed to reduce the possibility of seizing during tightening.
- Use a mallet to tap lightly on the large clamp bands to seat the diaphragm before tightening.

MAXIMUM TORQUE SPECIFICATIONS

Description of Part	Max. Torque
Air Valve	13.6 N·m (120 in·lb)
Air Chamber Bolts	27.1 N·m (20 ft·lb)
Outer Pistons, All	54.2 N·m (40 ft·lb)
Center Block-to-Stand Bolt	44.7 N·m (33 ft·lb)
Center Block-to-Bushing Bolt	44.7 N·m (33 ft·lb)
Locking Pin	44.7 N·m (33 ft·lb)
Anti-Rotation Bolt	67.8 N·m (50 ft·lb)



NOTE: To ensure proper alignment during reassembly of manifold/liquid chamber interface, turn off-set portion of valve housing to the left or to the right. This procedure works for the inlet manifold and discharge manifold connections.

SHAFT SEAL INSTALLATION:

PRE-INSTALLATION

- Once all of the old seals have been removed, the inside of the bushing should be cleaned to ensure no debris is left that may cause premature damage to the new seals.

INSTALLATION

The following tools can be used to aid in the installation of the new seals:

- Needle-Nose Pliers
- Phillips Screwdriver
- Electrical Tape

- Wrap electrical tape around each leg of the needle-nose pliers (heat shrink tubing may also be used). This is done to prevent damaging the inside surface of the new seal.
- With a new seal in hand, place the two legs of the needle-nose pliers inside the seal ring. (See Figure A.)
- Open the pliers as wide as the seal diameter will allow, then with two fingers pull down on the top portion of the seal to form a kidney shape. (See Figure B.)
- Lightly clamp the pliers together to hold the seal into the kidney shape. Be sure to pull the seal into as tight of a kidney shape as possible, this will allow the seal to travel down the bushing bore easier.
- With the seal clamped in the pliers, insert the seal into the bushing bore and position the bottom of the seal into the correct groove. Once the bottom of the seal is seated in the groove, release the clamp pressure on the pliers. This will allow the seal to partially snap back to its original shape.
- After the pliers are removed, you will notice a slight bump in the seal shape. Before the seal can be properly resized, the bump in the seal should be removed as much as possible. This can be done with either the Phillips screwdriver or your finger. With either the side of the screwdriver or your finger, apply light pressure to the peak of the bump. This pressure will cause the bump to be almost completely eliminated.
- Lubricate the edge of the shaft with NLGI grade 2 white EP bearing grease.
- Slowly insert the center shaft with a rotating motion. This will complete the resizing of the seal.
- Perform these steps for the remaining seals.

Figure A

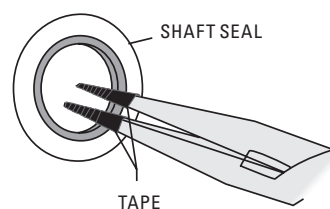
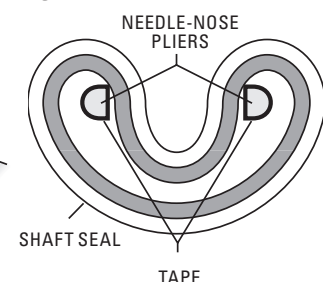

Figure B





CLEAN IN PLACE - CIP

The design of the PX8 HS pump allows for ease of cleaning and can be cleaned in place without disassembly. Before any cleaning is attempted, ensure that the cleaning fluids are compatible with all wetted components.

For best cleaning results, consider the following information prior to cleaning the PX8 HS pump.

- For best Clean-In-Place (CIP) results, the pump should be configured to either the EHEDG or 3-A configurations.
- Actual CIP effectiveness with pump user's product(s) and processes should be validated on location by the end user's quality assurance personnel to meet internal guidelines. Post-cleaning swab test is one method to accomplish this.
- The pump user should establish periodic inspections with full tear-down to verify that the CIP processes continue to be effective as first validated.
- Inlet pressure to the pump should not be greater than 0.7 bar (10 psig). Premature diaphragm failure will occur if greater than 0.7 bar (10 psig) is applied. If the pump is to be subjected to greater than 0.7 bar (10 psig), an optional diaphragm-balancing device is suggested to eliminate the possibility of the diaphragms being forced against the air chamber and subsequently causing premature diaphragm failure.

The following are some details to consider when cleaning the PX8 HS pump.

- Through the EHEDG certification process, the PX8 HS pump has been validated to clean equivalent to the inlet tubing of the same diameter. The cleaning chemical supplier should be consulted and advised of this for their chemical solution and application. The same guidelines for duration of cleaning cycle and temperature of cleaning fluid apply.

- Suggested flow rate for the PX8 HS pump is 11 m³/h (50 gpm) (usually higher is better).
- Typical CIP temperature is 77°C to 82°C (170°F to 180°F).
- Typical chemicals include NaOH (sodium hydroxide) caustic for wash and light acid and sanitizers for rinse.
- Once an initial CIP regimen is established, it may need to be modified to accommodate specific process and product differences or requirements. The most common adjustments include:
 - Changing cleaning time (extended or reduced pre-rinse, wash, rinses)
 - Changing cleaning flow rate
- The cleaning variables are related so that a pump user may be able to reduce the cleaning time by increasing the flow rate or chemical mix.
- Chlorinated sanitizers are known to cause premature failure of stainless steel and should be avoided.

To Clean Pump

- Activate the CIP system while slowly cycling the pump.

NOTE: A typical the CIP temperature limit is 90°C (195°F). If the CIP temperature is greater than 90°C (195°F), damage to the pump may occur.



EXPLODED VIEW & PARTS LISTING

PX8 SANIFLO™ HS

EXPLODED VIEW

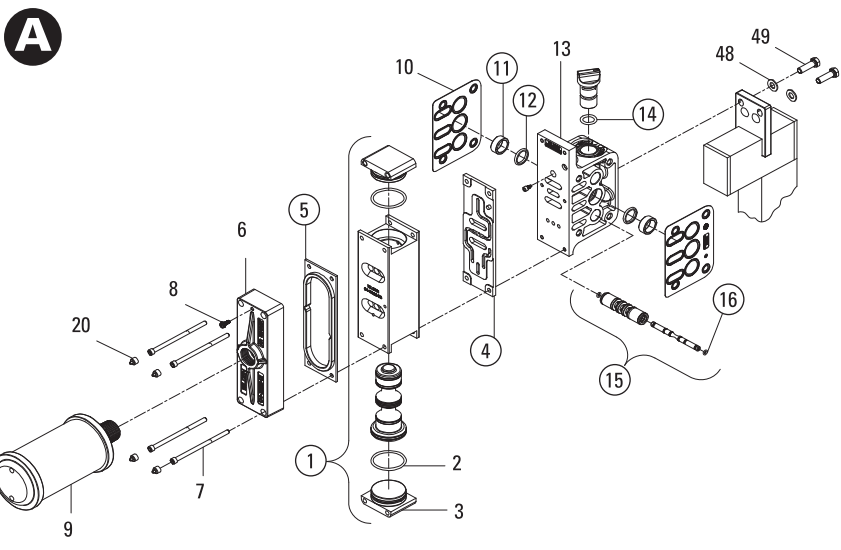
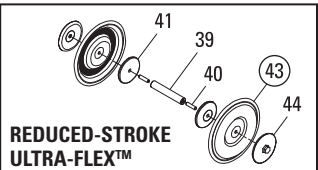
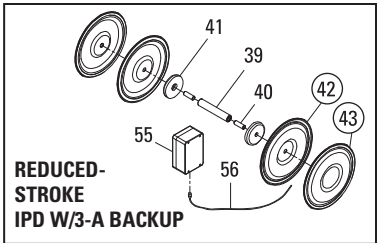
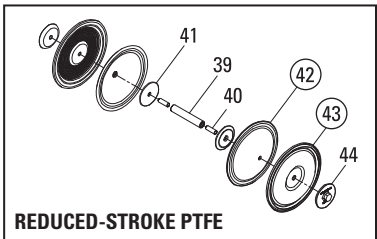
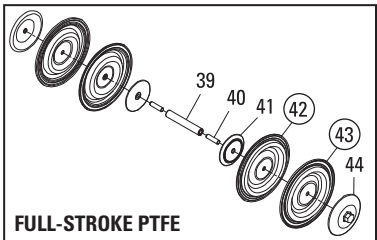
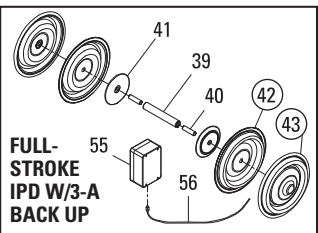
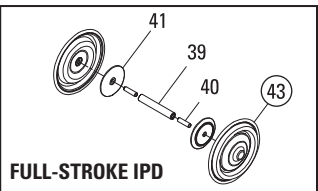
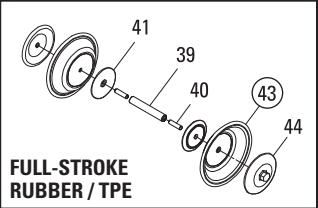
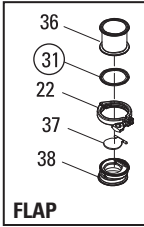
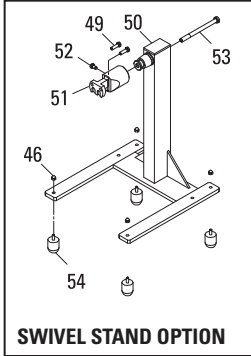
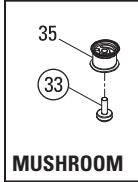
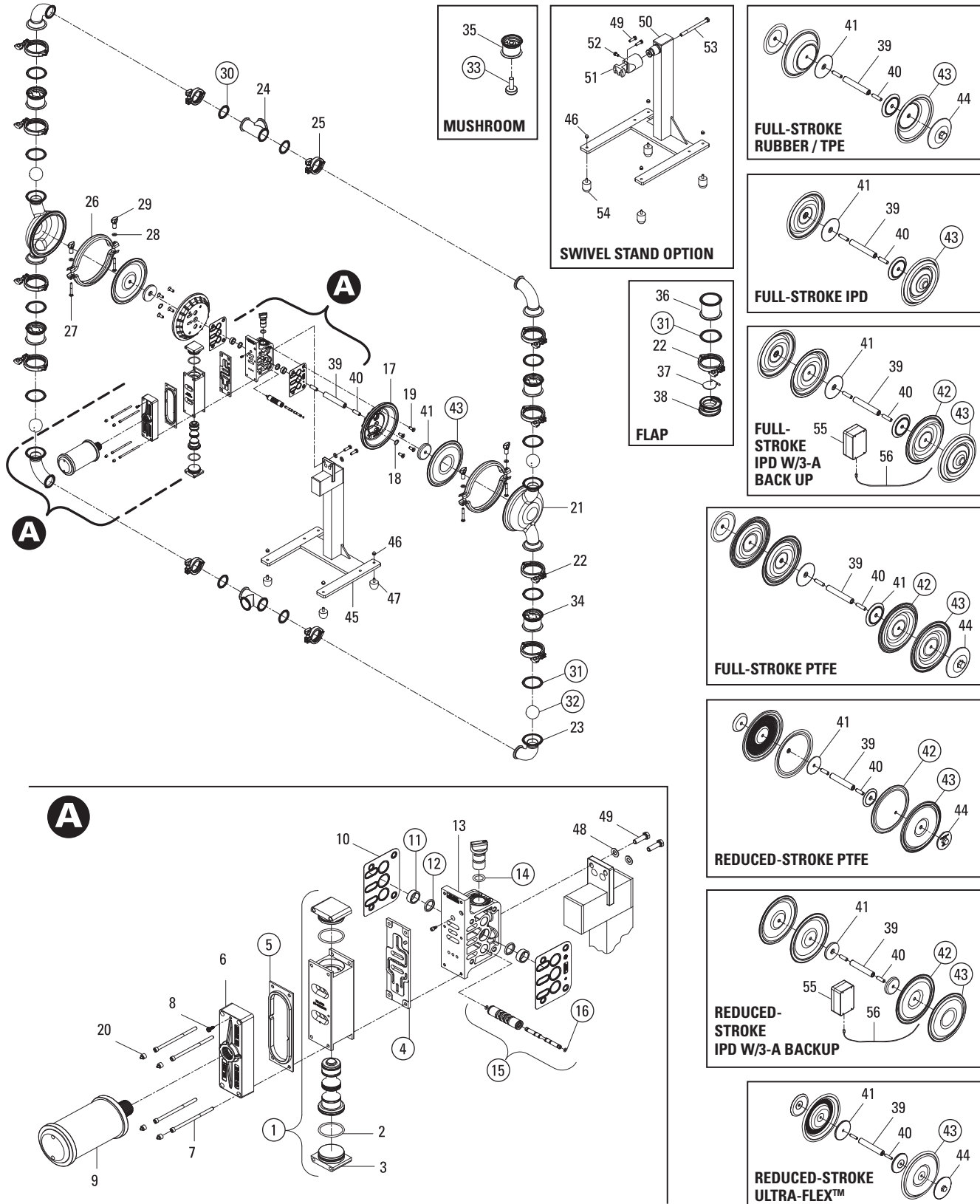

LW0123, Rev. C



EXPLODED VIEW & PARTS LISTING

WILDEN

PX8 SANIFLO™ HS

PARTS LISTING

Item	Description	Qty	NICKEL PLATED ADS			STAINLESS STEEL ADS		
			PX8 HS P/N	PX8 HS EHEDG P/N	PX8 HS 3-A P/N	PX8 HS P/N	PX8 HS EHEDG P/N	PX8 HS 3-A P/N
AIR DISTRIBUTION COMPONENTS								
1	Air Valve, Pro-Flo V™ ¹	1	04-2030-06	04-2030-06	04-2030-06	04-2030-03	04-2030-03	04-2030-03
2	O-Ring (-225), End Cap (Ø1.858" x Ø.139")	2	04-2390-52-700	04-2390-52-700	04-2390-52-700	04-2390-52-700	04-2390-52-700	04-2390-52-700
3	End Cap, Pro-Flo V™	2	04-2340-06	04-2340-06	04-2340-06	04-2340-03	04-2340-03	04-2340-03
4	Gasket, Air Valve, Pro-Flo V™	1	04-2620-52	04-2620-52	04-2620-52	04-2620-52	04-2620-52	04-2620-52
5	Gasket, Muffler Plate, Pro-Flo V™	1	04-3502-52	04-3502-52	04-3502-52	04-3502-52	04-3502-52	04-3502-52
6	Muffler Plate, Pro-Flo V™	1	04-3185-06	04-3185-06	04-3185-06	04-3185-03	04-3185-03	04-3185-03
7	Screw, SHC, Air Valve (1/4"-20 X 4.5")	4	01-6000-03	01-6000-03	01-6000-03	01-6000-03	01-6000-03	01-6000-03
8	Screw, 10-32 X .50 Self-Tapping Grounding	1	04-6345-08	04-6345-08	04-6345-08	04-6345-08	04-6345-08	04-6345-08
9	Sanitary Muffler	1	15-3510-06R	15-3510-06R	15-3510-06R	15-3510-06R	15-3510-06R	15-3510-06R
10	Gasket, Center Block, Pro-Flo V™	2	04-3529-52	04-3529-52	04-3529-52	04-3529-52	04-3529-52	04-3529-52
11	Bushing, Shaft	2	08-3306-13	08-3306-13	08-3306-13	08-3306-13	08-3306-13	08-3306-13
12	Shaft Seal	2	08-3210-55-225	08-3210-55-225	08-3210-55-225	08-3210-55-225	08-3210-55-225	08-3210-55-225
13	Center Block, Pro-Flo X™	1	08-3126-06	08-3126-06	08-3126-06	08-3126-03	08-3126-03	08-3126-03
14	O-Ring (-210), Adjuster (Ø.734" x Ø.139")	1	02-3200-52	02-3200-52	02-3200-52	02-3200-52	02-3200-52	02-3200-52
15	Removable Pilot Sleeve Assembly	1	04-3880-99	04-3880-99	04-3880-99	04-3880-99	04-3880-99	04-3880-99
16	Pilot Spool Retaining O-Ring	2	04-2650-49-700	04-2650-49-700	04-2650-49-700	04-2650-49-700	04-2650-49-700	04-2650-49-700
17	Air Chamber, Pro-Flo V™	2	04-3660-06	04-3660-06	04-3660-06	04-3660-03	04-3660-03	04-3660-03
18	Retaining Ring	2	04-3890-03	04-3890-03	04-3890-03	04-3890-03	04-3890-03	04-3890-03
19	Screw, HSFHS, 3/8"-16 X 1"	8	71-6250-08	71-6250-08	71-6250-08	71-6250-08	71-6250-08	71-6250-08
20	Plug, 1/4" SHCS (3-A)	4	N/A	N/A	02-7825-17	N/A	N/A	02-7825-17
WETTED PATH COMPONENTS								
▲ 21	Chamber, Liquid CIP 2" EHEDG	2	08-5000-10-385P	08-5000-10-385P	08-5000-10-385P	08-5000-10-385P	08-5000-10-385P	08-5000-10-385P
22	Clamp Band ASSY, 3"	8	15-7102-03	15-7102-03	15-7102-03	15-7102-03	15-7102-03	15-7102-03
▲ 23	Elbow, 2" EHEDG	4	08-5240-10-385P	08-5240-10-385P	08-5240-10-385P	08-5240-10-385P	08-5240-10-385P	08-5240-10-385P
▲ 24	T-Section, 2" EHEDG	2	08-5160-10-385P	08-5160-10-385P	08-5160-10-385P	08-5160-10-385P	08-5160-10-385P	08-5160-10-385P
	T-Section, 2" EHEDG DIN	2	08-5160-10-386P	08-5160-10-386P	N/A	08-5160-10-386P	08-5160-10-386P	N/A
	T-Section, 2" EHEDG SMS	2	08-5160-10-387P	08-5160-10-387P	N/A	08-5160-10-387P	08-5160-10-387P	N/A
25	Clamp Band, Assy, Medium	4	02-7200-03-85	02-7200-03-85	02-7200-03-85	02-7200-03-85	02-7200-03-85	02-7200-03-85
26	Clamp Band Assy, Large	2	04-7330-03-385	04-7330-03-385	04-7330-03-385	04-7330-03-385	04-7330-03-385	04-7330-03-385
27	Bolt, RHSN, 5/16"-18 X 2-1/2"	4	04-6070-03	04-6070-03	04-6070-03	04-6070-03	04-6070-03	04-6070-03
28	Washer, (Ø.343 X Ø.750 X .05)	4	01-6732-03	01-6732-03	01-6732-03	01-6732-03	01-6732-03	01-6732-03
29	Wing Nut, Medium Clamp	4	08-6661-10	08-6661-10	08-6661-10	08-6661-10	08-6661-10	08-6661-10
GASKETS/VALVE BALLS/MUSHROOM VALVE								
▲ 30	Gasket, 2"	4	*	*	*	*	*	*
▲ 31	Gasket, 3"	8	*	*	*	*	*	*
▲ 32	Valve Ball	4	*	*	*	*	*	*
▲ 33	Mushroom Valve	4	08-1096-55	N/A	N/A	08-1096-55	N/A	N/A
CHECK VALVE COMPONENTS								
▲ 34	Ball Cage, 2" EHEDG	4	08-5350-10-385P	08-5350-10-385P	08-5350-10-385P	08-5350-10-385P	08-5350-10-385P	08-5350-10-385P
▲ 35	Mushroom Valve Housing	4	08-5431-10-385P	N/A	N/A	08-5431-10-385P	N/A	N/A
▲ 36	Flap Valve Spacer 2"	4	08-5285-10-83P	N/A	N/A	08-5285-10-83P	N/A	N/A
▲ 37	Flap Valve 2"	4	08-1180-10-83P	N/A	N/A	08-1180-10-83P	N/A	N/A
▲ 38	Flap Valve Body 2"	4	08-5280-10-83P	N/A	N/A	08-5280-10-83P	N/A	N/A
FULL-STROKE RUBBER/TPE/PTFE/FSIPD COMPONENTS								
39	Shaft, Pro-Flo™, Non-PTFE	1	04-3800-03-700	04-3800-03-700	04-3800-03-700	04-3800-03-700	04-3800-03-700	04-3800-03-700
40	Shaft Stud, 1/2"-20 X 1 7/8"	2	08-6150-08	08-6150-08	08-6150-08	08-6150-08	08-6150-08	08-6150-08
41	Piston, Inner, P4 (Non-PTFE)	2	04-3700-01-700	04-3700-01-700	04-3700-01-700	04-3700-01-700	04-3700-01-700	04-3700-01-700
42	Diaphragm, Full-Stroke PTFE, Back-Up	2	*	N/A	N/A	*	N/A	N/A
	Diaphragm, Full-Stroke IPD, Back-Up (3-A)	2	N/A	N/A	04-1061-55	N/A	N/A	04-1061-55
▲ 43	Diaphragm, Primary	2	*	N/A	N/A	*	N/A	N/A
	Diaphragm, Full-Stroke PTFE, Primary	2	04-1040-55	N/A	N/A	04-1040-55	N/A	N/A
	Diaphragm, Full-Stroke IPD, Primary	2	N/A	04-1031-57	04-1031-57	N/A	04-1031-57	04-1031-57
▲ 44	Piston, Outer, (Non-PTFE)	2	04-4550-10-385P	N/A	N/A	04-4550-10-385P	N/A	N/A

LW0164 Rev. B

*Refer to Elastomer Chart

▲ Product Contact Components

¹Includes: items 2 and 3.

²Includes: items 27, 28 and 29.

³Includes: items 46 and 47.

⁴Includes: items 46, 51, 52, 53 and 54

All boldface items are primary wear parts.



EXPLODED VIEW & PARTS LISTING (CON'T)

PX8 SANIFLO™ HS

EXPLODED VIEW

Item	Description	Qty	NICKEL PLATED ADS			STAINLESS STEEL ADS		
			PX8 HS P/N	PX8 HS EHEDG P/N	PX8 HS 3-A P/N	PX8 HS P/N	PX8 HS EHEDG P/N	PX8 HS 3-A P/N
REDUCED-STROKE ULTRA-FLEX™ COMPONENTS								
39	Shaft, Pro-Flo™, Ultra-Flex™	1	04-3830-03-700	N/A	N/A	04-3830-03-700	N/A	N/A
40	Shaft Stud, 3/8"-16 X 1-1/2"	2	04-6152-08	N/A	N/A	04-6152-08	N/A	N/A
41	Piston, Inner, P4 (Ultra-Flex™)	2	04-3760-01-700	N/A	N/A	04-3760-01-700	N/A	N/A
▲ 43	Diaphragm, Primary, Ultra-Flex™	2	*	N/A	N/A	*	N/A	N/A
▲ 44	Piston, Outer, Ultra-Flex™	2	04-4560-10-385P	N/A	N/A	04-4560-10-385P	N/A	N/A
REDUCED-STROKE PTFE/IPD COMPONENTS								
39	Shaft, Pro-Flo™	1	04-3820-03-700	04-3820-03-700	04-3820-03-700	04-3820-03-700	04-3820-03-700	04-3820-03-700
40	Shaft Stud, 1/2"-20 X 1-1/2"	2	04-6150-08	04-6150-08	04-6150-08	04-6150-08	04-6150-08	04-6150-08
41	Piston, Inner, PTFE	2	04-3752-01	N/A	N/A	04-3752-01	N/A	N/A
	Piston, Inner, 1-1/2" EHEDG	2	N/A	04-3755-01	04-3755-01	N/A	04-3755-01	04-3755-01
42	Diaphragm, Back-Up	2	*	N/A	N/A	*	N/A	N/A
	Diaphragm, Back-Up, IPD (3-A)	2	N/A	N/A	04-1060-55	N/A	N/A	04-1060-55
▲ 43	Diaphragm, Primary PTFE	2	04-1010-55	N/A	N/A	04-1010-55	N/A	N/A
	Diaphragm, Integral Piston	2	N/A	04-1030-72	04-1030-72	N/A	04-1030-72	04-1030-72
▲ 44	Piston, Outer, PTFE	2	04-4600-10-385P	N/A	N/A	04-4600-10-385P	N/A	N/A
FIXED STAND COMPONENTS								
45	Stand, Pump, PV Assy. ³	1	08-7654-03	08-7654-03	N/A	08-7654-03	08-7654-03	N/A
46	Nut, Cap, 5/16"-18, Pump Stand	4	08-6600-03-72	08-6600-03-72	08-6600-03-72	08-6600-03-72	08-6600-03-72	08-6600-03-72
47	Pad, Pump Stand	4	08-7670-20	08-7670-20	N/A	08-7670-20	08-7670-20	N/A
48	Washer, Flat (Ø.406 X Ø.812 X .065)	2	04-6740-03	04-6740-03	N/A	04-6740-03	04-6740-03	N/A
49	Screw, HHC, 3/8"-16 X 1-1/4"	2	04-6190-03	04-6190-03	04-6190-03	04-6190-03	04-6190-03	04-6190-03
SWIVEL STAND COMPONENTS								
50	Pump Stand, Swivel, Assy. ⁴ (3-A)	1	08-7655-03	08-7655-03	08-7655-03	08-7655-03	08-7655-03	08-7655-03
51	Bushing, Center Block Mounting	1	15-7667-03	15-7667-03	15-7667-03	15-7667-03	15-7667-03	15-7667-03
52	Locking Pin	1	08-7694-03	08-7694-03	08-7694-03	08-7694-03	08-7694-03	08-7694-03
53	Screw, HHC, 1/2"-13 X 6"	1	15-6143-03	15-6143-03	15-6143-03	15-6143-03	15-6143-03	15-6143-03
49	Screw, HHC, 3/8"-16 X 1-1/4"	2	04-6190-03	04-6190-03	04-6190-03	04-6190-03	04-6190-03	04-6190-03
46	Nut, Cap, 5/16"-18, Pump Stand	4	08-6600-03-72	08-6600-03-72	08-6600-03-72	08-6600-03-72	08-6600-03-72	08-6600-03-72
54	Pad, Pump Stand 2" (3-A)	4	08-7672-20	08-7672-20	08-7672-20	08-7672-20	08-7672-20	08-7672-20
ACCESSORY COMPONENTS								
55	Control Module, Wil-Gard II, 110 (3-A)	1	65-8001-99	65-8001-99	65-8001-99	65-8001-99	65-8001-99	65-8001-99
56	Sensor Cables, Wil-Gard II (3-A)	1	65-8020-99	65-8020-99	65-8020-99	65-8020-99	65-8020-99	65-8020-99

LW0164 Rev. B

*Refer to Elastomer Chart

▲ Product Contact Components

¹Includes: items 2 and 3.

²Includes: items 27, 28 and 29.

³Includes: items 46 and 47.

⁴Includes: items 46, 51, 52, 53 and 54

All boldface items are primary wear parts.

EXPLODED VIEW & PARTS LISTING

PX8 SANIFLO™ HS

1935/2004/EC

EXPLODED VIEW

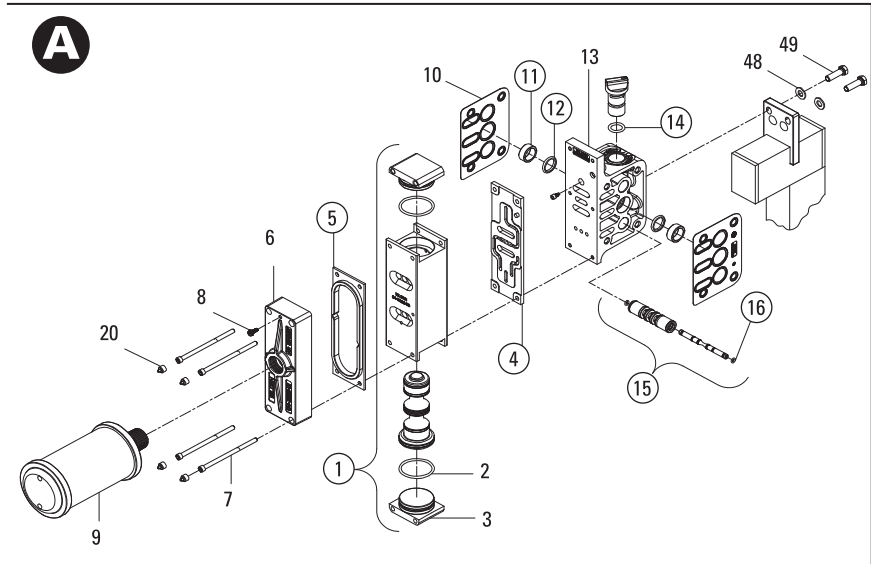
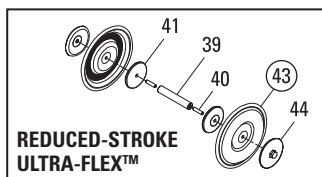
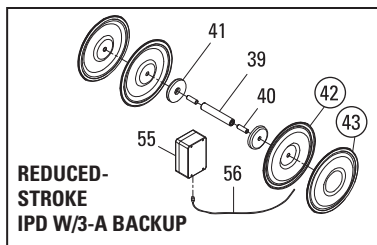
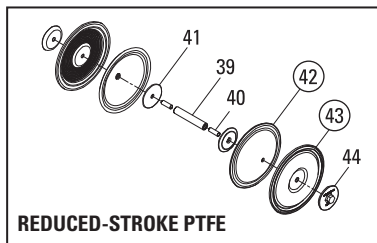
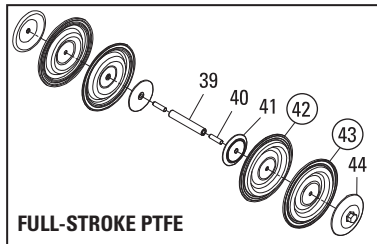
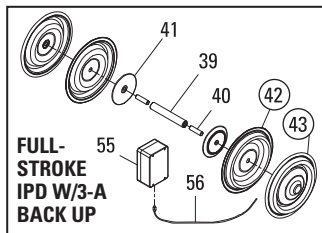
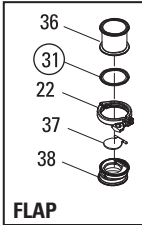
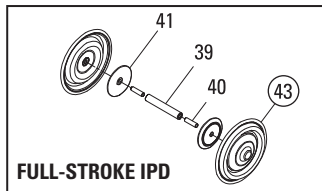
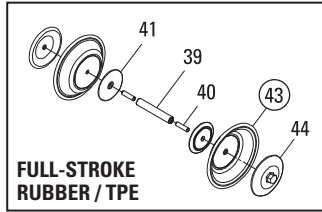
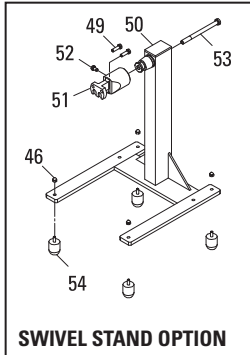
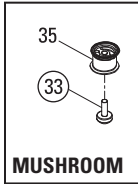
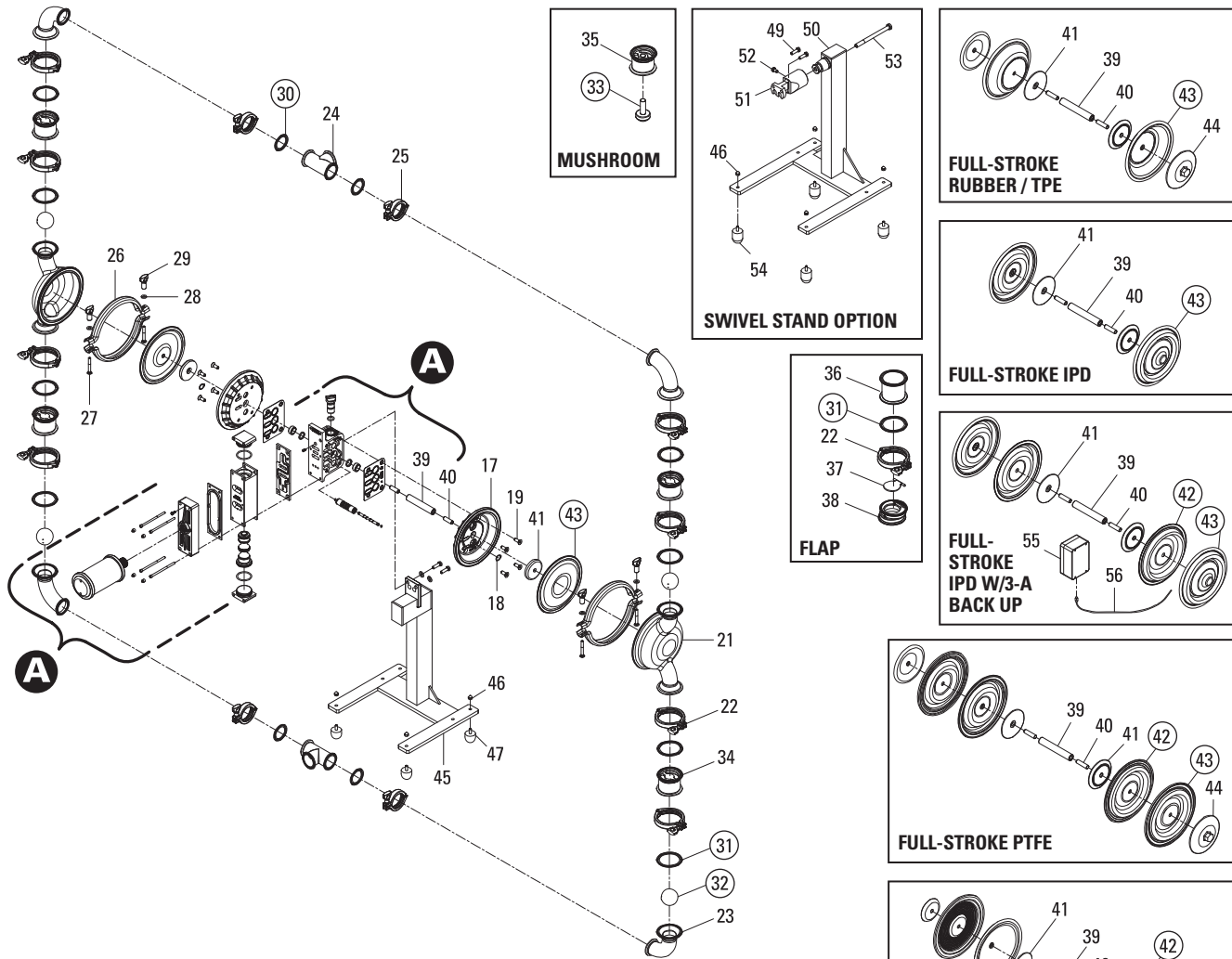



EXPLODED VIEW & PARTS LISTING

WILDEN

PX8 SANIFLO™ HS 1935/2004/E C

PARTS LISTING

Item	Description	Qty	NICKEL PLATED ADS			STAINLESS STEEL ADS		
			PX8 HS P/N	PX8 HS EHEDG P/N	PX8 HS 3-A P/N	PX8 HS P/N	PX8 HS EHEDG P/N	PX8 HS 3-A P/N
AIR DISTRIBUTION COMPONENTS								
1	Air Valve, Pro-Flo V™ ¹	1	04-2030-06	04-2030-06	04-2030-06	04-2030-03	04-2030-03	04-2030-03
2	O-Ring (-225), End Cap (Ø1.858" x Ø.139")	2	04-2390-52-700	04-2390-52-700	04-2390-52-700	04-2390-52-700	04-2390-52-700	04-2390-52-700
3	End Cap, Pro-Flo V™	2	04-2340-06	04-2340-06	04-2340-06	04-2340-03	04-2340-03	04-2340-03
4	Gasket, Air Valve, Pro-Flo V™	1	04-2620-52	04-2620-52	04-2620-52	04-2620-52	04-2620-52	04-2620-52
5	Gasket, Muffler Plate, Pro-Flo V™	1	04-3502-52	04-3502-52	04-3502-52	04-3502-52	04-3502-52	04-3502-52
6	Muffler Plate, Pro-Flo V™	1	04-3185-06	04-3185-06	04-3185-06	04-3185-03	04-3185-03	04-3185-03
7	Screw, SHC, Air Valve (1/4"-20 X 4.5")	4	01-6000-03	01-6000-03	01-6000-03	01-6000-03	01-6000-03	01-6000-03
8	Screw, 10-32 X .50 Self-Tapping Grounding	1	04-6345-08	04-6345-08	04-6345-08	04-6345-08	04-6345-08	04-6345-08
9	Sanitary Muffler	1	15-3510-06R	15-3510-06R	15-3510-06R	15-3510-06R	15-3510-06R	15-3510-06R
10	Gasket, Center Block, Pro-Flo V™	2	04-3529-52	04-3529-52	04-3529-52	04-3529-52	04-3529-52	04-3529-52
11	Bushing, Shaft	2	08-3306-13	08-3306-13	08-3306-13	08-3306-13	08-3306-13	08-3306-13
12	Shaft Seal	2	08-3210-55-225	08-3210-55-225	08-3210-55-225	08-3210-55-225	08-3210-55-225	08-3210-55-225
13	Center Block, Pro-Flo X™	1	08-3126-06	08-3126-06	08-3126-06	08-3126-03	08-3126-03	08-3126-03
14	O-Ring (-210), Adjuster (Ø.734" x Ø.139")	1	02-3200-52	02-3200-52	02-3200-52	02-3200-52	02-3200-52	02-3200-52
15	Removable Pilot Sleeve Assembly	1	04-3880-99	04-3880-99	04-3880-99	04-3880-99	04-3880-99	04-3880-99
16	Pilot Spool Retaining O-Ring	2	04-2650-49-700	04-2650-49-700	04-2650-49-700	04-2650-49-700	04-2650-49-700	04-2650-49-700
17	Air Chamber, Pro-Flo V™	2	04-3660-06	04-3660-06	04-3660-06	04-3660-03	04-3660-03	04-3660-03
18	Retaining Ring	2	04-3890-03	04-3890-03	04-3890-03	04-3890-03	04-3890-03	04-3890-03
19	Screw, HSFHS, 3/8"-16 X 1"	8	71-6250-08	71-6250-08	71-6250-08	71-6250-08	71-6250-08	71-6250-08
20	Plug, 1/4" SHCS (3-A)	4	N/A	N/A	02-7825-17	N/A	N/A	02-7825-17
WETTED PATH COMPONENTS								
▲ 21	Chamber, Liquid CIP 2" EHEDG	2	08-5000-10-385P	08-5000-10-385P	08-5000-10-385P	08-5000-10-385P	08-5000-10-385P	08-5000-10-385P
22	Clamp Band ASSY, 3"	8	15-7102-03	15-7102-03	15-7102-03	15-7102-03	15-7102-03	15-7102-03
▲ 23	Elbow, 2" EHEDG	4	08-5240-10-385P	08-5240-10-385P	08-5240-10-385P	08-5240-10-385P	08-5240-10-385P	08-5240-10-385P
▲ 24	T-Section, 2" EHEDG	2	08-5160-10-385P	08-5160-10-385P	08-5160-10-385P	08-5160-10-385P	08-5160-10-385P	08-5160-10-385P
	T-Section, 2" EHEDG DIN	2	08-5160-10-386P	08-5160-10-386P	N/A	08-5160-10-386P	08-5160-10-386P	N/A
	T-Section, 2" EHEDG SMS	2	08-5160-10-387P	08-5160-10-387P	N/A	08-5160-10-387P	08-5160-10-387P	N/A
25	Clamp Band, Assy, Medium	4	02-7200-03-85	02-7200-03-85	02-7200-03-85	02-7200-03-85	02-7200-03-85	02-7200-03-85
26	Clamp Band Assy, Large	2	04-7330-03-385	04-7330-03-385	04-7330-03-385	04-7330-03-385	04-7330-03-385	04-7330-03-385
27	Bolt, RHSN, 5/16"-18 X 2-1/2"	4	04-6070-03	04-6070-03	04-6070-03	04-6070-03	04-6070-03	04-6070-03
28	Washer, (Ø.343 X Ø.750 X .05)	4	01-6732-03	01-6732-03	01-6732-03	01-6732-03	01-6732-03	01-6732-03
29	Wing Nut, Medium Clamp	4	08-6661-10	08-6661-10	08-6661-10	08-6661-10	08-6661-10	08-6661-10
GASKETS/VALVE BALLS/MUSHROOM VALVE								
▲ 30	Gasket, 2", Pkg 2	2	*	*	*	*	*	*
▲ 31	Gasket, 3", Pkg 4	2	*	*	*	*	*	*
▲ 32	Valve Ball, Pkg 4	1	*	*	*	*	*	*
▲ 33	Mushroom Valve, Pkg 4	1	08-1096-55E	N/A	N/A	08-1096-55E	N/A	N/A
CHECK VALVE COMPONENTS								
▲ 34	Ball Cage, 2" EHEDG	4	08-5350-10-385P	08-5350-10-385P	08-5350-10-385P	08-5350-10-385P	08-5350-10-385P	08-5350-10-385P
▲ 35	Mushroom Valve Housing	4	08-5431-10-385P	N/A	N/A	08-5431-10-385P	N/A	N/A
▲ 36	Flap Valve Spacer 2"	4	08-5285-10-83P	N/A	N/A	08-5285-10-83P	N/A	N/A
▲ 37	Flap Valve 2"	4	08-1180-10-83P	N/A	N/A	08-1180-10-83P	N/A	N/A
▲ 38	Flap Valve Body 2"	4	08-5280-10-83P	N/A	N/A	08-5280-10-83P	N/A	N/A
FULL-STROKE RUBBER/TPE/PTFE/FSIPD COMPONENTS								
39	Shaft, Pro-Flo™, Non-PTFE	1	04-3800-03-700	04-3800-03-700	04-3800-03-700	04-3800-03-700	04-3800-03-700	04-3800-03-700
40	Shaft Stud, 1/2"-20 X 1 7/8"	2	08-6150-08	08-6150-08	08-6150-08	08-6150-08	08-6150-08	08-6150-08
41	Piston, Inner, P4 (Non-PTFE)	2	04-3700-01-700	04-3700-01-700	04-3700-01-700	04-3700-01-700	04-3700-01-700	04-3700-01-700
42	Diaphragm, Full-Stroke PTFE, Back-Up, Pkg 2	1	*	N/A	N/A	*	N/A	N/A
	Diaphragm, Full-Stroke IPD, Back-Up (3-A), Pkg 2	1	N/A	N/A	04-1061-55E	N/A	N/A	04-1061-55E
▲ 43	Diaphragm, Primary, Pkg 2	1	*	N/A	N/A	*	N/A	N/A
	Diaphragm, Full-Stroke PTFE, Primary, Pkg 2	1	04-1040-55E	N/A	N/A	04-1040-55E	N/A	N/A
	Diaphragm, Full-Stroke IPD, Primary, Pkg 2	1	N/A	04-1031-57E	04-1031-57E	N/A	04-1031-57E	04-1031-57E
▲ 44	Piston, Outer, (Non-PTFE)	2	04-4550-10-385P	N/A	N/A	04-4550-10-385P	N/A	N/A

LW0118 Rev. C

*Refer to Elastomer Chart

▲ Product Contact Components

¹Includes: items 2 and 3.

²Includes: items 27, 28 and 29.

³Includes: items 46 and 47.

⁴Includes: items 46, 51, 52, 53 and 54

All boldface items are primary wear parts.



EXPLODED VIEW & PARTS LISTING (CON'T)

PX8 SANIFLO™ HS

1935/2004/EC

PARTS LISTING

Item	Description	Qty	NICKEL PLATED ADS			STAINLESS STEEL ADS		
			PX8 HS P/N	PX8 HS EHEDG P/N	PX8 HS 3-A P/N	PX8 HS P/N	PX8 HS EHEDG P/N	PX8 HS 3-A P/N
REDUCED-STROKE ULTRA-FLEX™ COMPONENTS								
39	Shaft, Pro-Flo™, Ultra-Flex™	1	04-3830-03-700	N/A	N/A	04-3830-03-700	N/A	N/A
40	Shaft Stud, 3/8"-16 X 1-1/2"	2	04-6152-08	N/A	N/A	04-6152-08	N/A	N/A
41	Piston, Inner, P4 (Ultra-Flex™)	2	04-3760-01-700	N/A	N/A	04-3760-01-700	N/A	N/A
▲ 43	Diaphragm, Primary, Ultra-Flex™, Pkg 2	1	*	N/A	N/A	*	N/A	N/A
▲ 44	Piston, Outer, Ultra-Flex™	2	04-4560-10-385P	N/A	N/A	04-4560-10-385P	N/A	N/A
REDUCED-STROKE PTFE/IPD COMPONENTS								
39	Shaft, Pro-Flo™	1	04-3820-03-700	04-3820-03-700	04-3820-03-700	04-3820-03-700	04-3820-03-700	04-3820-03-700
40	Shaft Stud, 1/2"-20 X 1-1/2"	2	04-6150-08	04-6150-08	04-6150-08	04-6150-08	04-6150-08	04-6150-08
41	Piston, Inner, PTFE	2	04-3752-01	N/A	N/A	04-3752-01	N/A	N/A
	Piston, Inner, 1-1/2" EHEDG	2	N/A	04-3755-01	04-3755-01	N/A	04-3755-01	04-3755-01
42	Diaphragm, Back-Up, Pkg 2	1	*	N/A	N/A	*	N/A	N/A
	Diaphragm, Back-Up, IPD (3-A), Pkg 2	1	N/A	N/A	04-1060-55E	N/A	N/A	04-1060-55E
▲ 43	Diaphragm, Primary PTFE, Pkg 2	1	04-1010-55E	N/A	N/A	04-1010-55E	N/A	N/A
▲ 44	Diaphragm, Integral Piston, Pkg 2	1	N/A	04-1030-72E	04-1030-72E	N/A	04-1030-72E	04-1030-72E
▲ 44	Piston, Outer, PTFE	2	04-4600-10-385P	N/A	N/A	04-4600-10-385P	N/A	N/A
FIXED STAND COMPONENTS								
45	Stand, Pump, PV Assy. ³	1	08-7654-03	08-7654-03	N/A	08-7654-03	08-7654-03	N/A
46	Nut, Cap, 5/16"-18, Pump Stand	4	08-6600-03-72	08-6600-03-72	08-6600-03-72	08-6600-03-72	08-6600-03-72	08-6600-03-72
47	Pad, Pump Stand	4	08-7670-20	08-7670-20	N/A	08-7670-20	08-7670-20	N/A
48	Washer, Flat (Ø.406 X Ø.812 X .065)	2	04-6740-03	04-6740-03	N/A	04-6740-03	04-6740-03	N/A
49	Screw, HHC, 3/8"-16 X 1-1/4"	2	04-6190-03	04-6190-03	04-6190-03	04-6190-03	04-6190-03	04-6190-03
SWIVEL STAND COMPONENTS								
50	Pump Stand, Swivel, Assy. ⁴ (3-A)	1	08-7655-03	08-7655-03	08-7655-03	08-7655-03	08-7655-03	08-7655-03
51	Bushing, Center Block Mounting	1	15-7667-03	15-7667-03	15-7667-03	15-7667-03	15-7667-03	15-7667-03
52	Locking Pin	1	08-7694-03	08-7694-03	08-7694-03	08-7694-03	08-7694-03	08-7694-03
53	Screw, HHC, 1/2"-13 X 6"	1	15-6143-03	15-6143-03	15-6143-03	15-6143-03	15-6143-03	15-6143-03
49	Screw, HHC, 3/8"-16 X 1-1/4"	2	04-6190-03	04-6190-03	04-6190-03	04-6190-03	04-6190-03	04-6190-03
46	Nut, Cap, 5/16"-18, Pump Stand	4	08-6600-03-72	08-6600-03-72	08-6600-03-72	08-6600-03-72	08-6600-03-72	08-6600-03-72
54	Pad, Pump Stand 2" (3-A)	4	08-7672-20	08-7672-20	08-7672-20	08-7672-20	08-7672-20	08-7672-20
ACCESSORY COMPONENTS								
55	Control Module, Wil-Gard II, 110 (3-A)	1	65-8001-99	65-8001-99	65-8001-99	65-8001-99	65-8001-99	65-8001-99
56	Sensor Cables, Wil-Gard II (3-A)	1	65-8020-99	65-8020-99	65-8020-99	65-8020-99	65-8020-99	65-8020-99

LW0118 Rev. C

*Refer to Elastomer Chart

▲ Product Contact Components

¹Includes: items 2 and 3.

²Includes: items 27, 28 and 29.

³Includes: items 46 and 47.

⁴Includes: items 46, 51, 52, 53 and 54

All boldface items are primary wear parts.



ELASTOMER OPTIONS

PX8 SANIFLO™ HS

MATERIAL	DIAPHRAGMS (Color Code)	BACK-UP DIAPHRAGMS REDUCED-STROKE (Color Code)	BACK-UP DIAPHRAGMS FULL-STROKE (Color Code)	ULTRA-FLEX™ DIAPHRAGMS (Color Code)	VALVE BALL (Color Code)	GASKET, 2" (Color Code)	GASKET, 3" (Color Code)
FDA BUNA-N	04-1010-69 (2 yellow dots)	N/A	N/A	04-1020-52 (red dot)	08-1086-69 (2 yellow dots)	08-1375-69 (red dot)	15-1375-69 (red dot)
FDA EPDM	04-1010-74 (2 blue dots)	04-1060-54 (blue dot)	N/A	04-1020-54 (blue dot)	08-1086-74 (2 blue dots)	08-1375-74 (green dot)	15-1375-74 (green dot)
SANIFLEX™	04-1010-56 (cream)	04-1060-56 (cream)	04-1065-56 (cream)	N/A	08-1086-56 (cream)	N/A	N/A
PTFE	**	N/A	N/A	N/A	08-1086-55 (white)	08-1375-55 (white)	15-1375-55 (white)
FULL-STROKE PTFE	04-1040-55 (white)	N/A	N/A	N/A	08-1086-55 (white)	08-1375-55 (white)	15-1375-55 (white)
FDA WIL-FLEX™	04-1022-57 (2 orange dots)	N/A	04-1065-57 (2 orange dots)	N/A	08-1086-57 (2 orange dots)	N/A	N/A
FDA VITON®	N/A	N/A	N/A	N/A	N/A	02-1400-68-85 (white/yellow)	15-1375-68 (white/yellow)

** See BOM Chart

▲ Product Contact Components

LW0164 Rev. B

PX8 SANIFLO™ HS 1935/2004/EC

MATERIAL	DIAPHRAGMS (Color Code)	REDUCED-STROKE BACK-UP DIAPHRAGMS (Color Code)	FULL-STROKE BACK-UP DIAPHRAGMS (Color Code)	ULTRA-FLEX™ DIAPHRAGMS (Color Code)	VALVE BALL (Color Code)	GASKET, 2" (Color Code)	GASKET, 3" (Color Code)
FDA BUNA-N	04-1010-69E (2 yellow dots)	N/A	N/A	04-1020-52E (red dot)	08-1086-69E (2 yellow dots)	08-1375-69E (red dot)	15-1375-69E (red dot)
FDA EPDM	04-1010-74E (2 blue dots)	04-1060-54E (blue dot)	N/A	04-1020-54E (blue dot)	08-1086-74E (2 blue dots)	08-1375-74E (green dot)	15-1375-74E (green dot)
SANIFLEX™	04-1010-56E (cream)	04-1060-56E (cream)	04-1065-56E (cream)	N/A	08-1086-56E (cream)	N/A	N/A
PTFE	**	N/A	N/A	N/A	08-1086-55E (white)	08-1375-55E (white)	15-1375-55E (white)
FULL-STROKE PTFE	04-1040-55E (white)	N/A	N/A	N/A	N/A	N/A	N/A
FDA WIL-FLEX™	04-1022-57E (2 orange dots)	N/A	04-1065-57E (2 orange dots)	N/A	08-1086-57E (2 orange dots)	N/A	N/A
FDA VITON®	N/A	N/A	N/A	N/A	N/A	02-1400-68-85E (white/yellow)	15-1375-68E (white/yellow)

** See BOM Chart

▲ Product Contact Components

LW0118, Rev. C

ISSUE DATE: JUNE 22, 1995

CERTIFICATE AUTHORIZATION NUMBER: 833



THIS IS TO CERTIFY THAT

Wilden Pump & Engineering LLC

22069 Van Buren Street Grand Terrace, CA 92313-5651

is hereby authorized to continue to apply the
3-A Symbol to the models of equipment, conforming to 3-A Sanitary Standards for:

**Number 44-03
Diaphragm Pumps**

set forth below

CIP Models: PX, XPX, PS, XPS, Sizes: 02, 04, 08, 15; Wetted Housing: SZ; Center /
Air Valve: NNN, SSS; Diaphragms: LEL, FWL; Check Balls: FB, FE, FS, FW, TF;
Gaskets: FB, FE, FV, TF; Leak Detection: 0774, 0775.

VALID THROUGH: **December 31, 2015**

Timothy R. Rugh
Executive Director
3-A Sanitary Standards, Inc.

The issuance of this authorization for the use of the 3-A Symbol is based upon the voluntary certification, by the applicant for it, that the equipment listed above complies fully with the 3-A Sanitary Standards designated. Legal responsibility for compliance is solely that of the holder of this Certificate of Authorization, and 3-A Sanitary Standards, Inc. does not warrant that the holder of an authorization at all times complies with the provisions of the said 3-A Sanitary Standard. This in no way affects the responsibility of 3-A Sanitary Standards, Inc. to take appropriate action in such cases in which evidence of nonconformance had been established.

NEXT TPV INSPECTION/REPORT DUE: **March 2020**

CERTIFICATE OF COMPLIANCE



TNO Certification hereby declares that the product

Air operated double Diaphragm Pump type Saniflo HS size 1.0" to 3.0"

From

Wilden Pump & Engineering, LLC, Grand Terrace, USA

has been evaluated for compliance with the Hygienic Equipment Design Criteria of the EHEDG, Document No. 8, by:

TNO Quality of Life at Zeist, Netherlands and meets the criteria of this document as demonstrated by:

Evaluation Report No. V6621RE

Signed [Signature]
Evaluation Officer

Date June 15, 2006

Signed [Signature]
Managing Director, TNO Certification

Date June 15, 2006



Certificate No. C06-8337

WILDEN®

DECLARATION OF COMPLIANCE

STATEMENT OF COMPLIANCE TO REGULATIONS (EC) No 1935/2004
ON MATERIALS AND ARTICLES INTENDED TO COME INTO CONTACT WITH FOOD
(as per Article 16 of REGULATION (EC) No 1935/2004)



Wilden® Pump & Engineering, LLC, 22069 Van Buren Street, Grand Terrace, CA 92313-5607 USA, declares the equipment listed below intended to come into contact with food comply with the requirements of Regulation (EC) No 1935/2004 of 27th October 2004 and (EC) No 2023/2006 of 22nd December 2006.

- **Saniflo™ HS Models:**
(PX,XPX)(2,4,8,15)/(SS,SZ)(SSS,NNN)/(BNU,EPU,FBS,FES,FSS,FWL,FWS,LEL,TEU,TSS,TSU,TWS,ZSS)/
(FB,FE,FS,FV,FW,SF,TF,TM)/(FB,FE,FV,TF)/(0770-0789)E
- **13 mm (½") FDA Pro-Flo® & Pro-Flo X™ Models:**
(P,PX,XPX)1/(SS,SZ)(AAA,GGG,JJJ,LLL,PPP)/(FSS,TEU,TSU)/(FS,TF)/S(FS,TF)/(0067,0070,0120)E
- **25 mm (1") FDA Pro-Flo® Models:**
P2/(SS,SZ)(LLL,PPP)/(FBS,FES,FSS,FWL,FWS,LEL,TEU,TSS,TSU,TWS)/(FS,TF)/S(FS,TF)/2070E
- **38 mm (1-½") FDA Pro-Flo® & Pro-Flo X™ Models:**
(P,PX,XPX)4/(SS,SZ)(A,C,L,N,S,V)(AA,LL,NN,PP,SS)/(BNU,EPU,FBS,FES,FSS,FWL,FWS,LEL,TEU,TSS,TSU,TWS,ZSS)/
(FB,FE,FS,FV,FW,TF,)/(FS,FW,STF)/(0067,0070,0075,0120)E
- **51 mm (2") FDA Pro-Flo® & Pro-Flo X™ Models:**
(P,PX,XPX)8/SS(A,C,N,S,V)(AA,NN,PP,SS)/(BNU,EPU,FBS,FES,FSS,FWS,FWL,TEU,TSU,TSS,TWS,ZSS)/(FS,FW,TF)/
(FS,FW,STF)/(0070,0075,0120)E
- **76 mm (3") FDA Pro-Flo X™ Models:**
(PX,XPX)15/SS(A,C,N,S)(AA,SS,PP)/(BNU,EPU,FSS,FWL,FWS,TEU,TSU,TSS,TWS,ZSS)/(FS,FW,TF)/(FS,FW,STF)/
(0070,0075,0120,0341)E
- **38 mm (1-½") FDA Pro-Flo® SHIFT Models:**
XPS4/(SS,SZ)(AAA,NNN)/(FBS,FES,FWL,FWS,TSS,TWS,ZSS)/(FS,FW,TF)/(FS,FW,STF)/(0067,0070,0075,0120)E
- **51 mm (2") FDA Pro-Flo® SHIFT Models:**
XPS8/(SS,SZ)(AAA,NNN)/(FBS,FES,FWL,FWS,TSS,TWS,ZSS)/(FS,FW,TF)/(FS,FW,STF)/(0070,0075,0120)E
- **76 mm (3") FDA Pro-Flo® SHIFT Models:**
XPS15/(SS,SZ)(AAA,NNN)/(FWL,FWS,TSS,TWS,ZSS)/(FS,FW,TF)/(FS,FW,STF)/(0070,0120,0341)E

Materials used in the equipment that are intended to contact food belong to the groups of materials listed in Annex 1 (EC) 1935/2004.
(List of groups of materials and articles that may be covered by specific measures)

5) Rubbers 8) Metal and Alloy 10) Plastics

Compliance is subject to material and equipment storage, handling and usage recommended by **Wilden®** in the engineering operation and maintenance manual and supplemental technical publications.

This declaration is based on the following information:
 Statements of raw material suppliers

Wilden® will make available to the competent authorities appropriate documentation to demonstrate compliance.

Approved By:

Chris Distaso
Director of Engineering
Date: March 17, 2015



WARRANTY

Each and every product manufactured by Wilden Pump and Engineering, LLC is built to meet the highest standards of quality. Every pump is functionally tested to insure integrity of operation.

Wilden Pump and Engineering, LLC warrants that pumps, accessories and parts manufactured or supplied by it to be free from defects in material and workmanship for a period of five (5) years from date of installation or six (6) years from date of manufacture, whichever comes first. Failure due to normal wear, misapplication, or abuse is, of course, excluded from this warranty.

Since the use of Wilden pumps and parts is beyond our control, we cannot guarantee the suitability of any pump or part for a particular application and Wilden Pump and Engineering, LLC shall not be liable for any consequential damage or expense arising from the use or misuse of its products on any application. Responsibility is limited solely to replacement or repair of defective Wilden pumps and parts.

All decisions as to the cause of failure are the sole determination of Wilden Pump and Engineering, LLC.

Prior approval must be obtained from Wilden for return of any items for warranty consideration and must be accompanied by the appropriate MSDS for the product(s) involved. A Return Goods Tag, obtained from an authorized Wilden distributor, must be included with the items which must be shipped freight prepaid.

The foregoing warranty is exclusive and in lieu of all other warranties expressed or implied (whether written or oral) including all implied warranties of merchantability and fitness for any particular purpose. No distributor or other person is authorized to assume any liability or obligation for Wilden Pump and Engineering, LLC other than expressly provided herein.

PLEASE PRINT OR TYPE AND FAX TO WILDEN

PUMP INFORMATION			
Item # _____		Serial # _____	
Company Where Purchased _____			
YOUR INFORMATION			
Company Name _____			
Industry _____			
Name _____		Title _____	
Street Address _____			
City _____	State _____	Postal Code _____	Country _____
Telephone _____	Fax _____	E-mail _____	Web Address _____
Number of pumps in facility? _____		Number of Wilden pumps? _____	
Types of pumps in facility (check all that apply): <input type="checkbox"/> Diaphragm <input type="checkbox"/> Centrifugal <input type="checkbox"/> Gear <input type="checkbox"/> Submersible <input type="checkbox"/> Lobe			
<input type="checkbox"/> Other _____			
Media being pumped? _____			
How did you hear of Wilden Pump? <input type="checkbox"/> Trade Journal <input type="checkbox"/> Trade Show <input type="checkbox"/> Internet/E-mail <input type="checkbox"/> Distributor			
<input type="checkbox"/> Other _____			

ONCE COMPLETE, FAX TO (909) 783-3440

NOTE: WARRANTY VOID IF PAGE IS NOT FAXED TO WILDEN

WILDEN PUMP & ENGINEERING, LLC



Where Innovation Flows

PSG reserves the right to modify the information and illustrations contained in this document without prior notice. This is a non-contractual document. 07-2015

WILDEN®

PSG

22069 Van Buren St., Grand Terrace, CA 92313-5607

P: +1 (909) 422-1731 • F: +1 (909) 783-3440

wildenpump.com

Authorized PSG Representative:

Copyright ©2015, PSG, A Dover Company