

T810

Advanced™ Series **METAL** Pumps

EOM

Engineering
Operation &
Maintenance



Advance your process

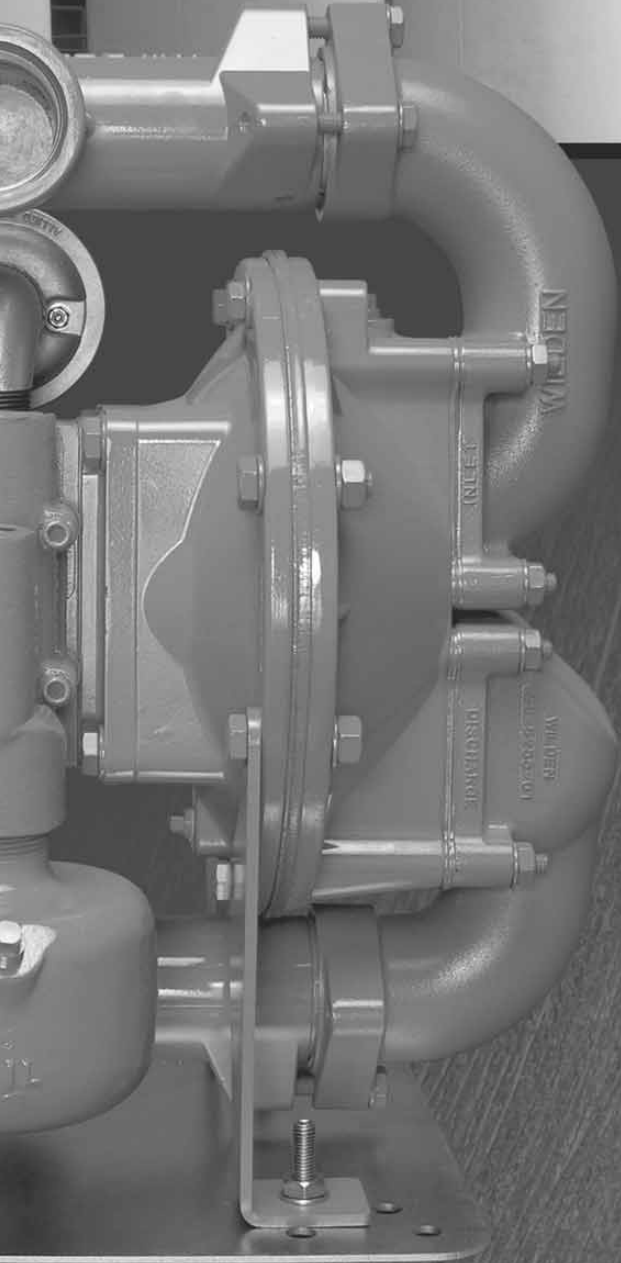

TURBO-FLO™
PROGRESSIVE PUMP TECHNOLOGY

WILDEN®

A **DOVER** COMPANY

WIL-11140-E-03
REPLACES WIL-11140-E-02

TABLE OF CONTENTS

SECTION 1 CAUTIONS—READ FIRST!1

SECTION 2 WILDEN PUMP DESIGNATION SYSTEM2

SECTION 3 HOW IT WORKS—PUMP & AIR DISTRIBUTION SYSTEM3

SECTION 4 DIMENSIONAL DRAWING4

SECTION 5 PERFORMANCE

 A. Performance Curve

 Rubber5

 B. Suction Lift Curve5

SECTION 6 SUGGESTED INSTALLATION, OPERATION & TROUBLESHOOTING.....6

SECTION 7 DISASSEMBLY / REASSEMBLY9

SECTION 8 EXPLODED VIEW & PARTS LISTING

 Wetted Path18



















 Center Section Assembly.....20

 Inlet Flap Assemblies22

SECTION 9 ELASTOMER OPTIONS & CONVERSION KIT24



CAUTIONS—READ FIRST!

-  **CAUTION:** Do not apply compressed air to the exhaust port — pump will not function.
-  **CAUTION:** Do not over-lubricate air supply — excess lubrication will reduce pump performance.
-  **NOTE:** All non lube-free air-operated pumps must be lubricated. Wilden suggests an arctic 5 weight oil (ISO grade 15). Do no over lubricate pump. Excess lubrication will reduce pump performance.
-  **TEMPERATURE LIMITS:**
- | | | |
|--------------------------------|----------------|----------------|
| Neoprene | -18°C to 93°C | 0°F to 200°F |
| Buna-N | -12°C to 82°C | 10°F to 180°F |
| EPDM | -51°C to 138°C | -60°F to 280°F |
| Viton® | -40°C to 177°C | -40°F to 350°F |
| Saniflex™ | -29°C to 104°C | -20°F to 220°F |
| Polytetrafluoroethylene (PTFE) | 4°C to 104°C | 40°F to 220°F |
| Polyurethane | -12°C to 66°C | 10°F to 150°F |
- NOTE: Not all materials are available for all models. Refer to Section 2 for material options for your pump.
-  **CAUTION:** When choosing pump materials, be sure to check the temperature limits for all wetted components. Example: Viton® has a maximum limit of 177°C (350°F) but polypropylene has a maximum limit of only 79°C (175°F).
-  **CAUTION:** Maximum temperature limits are based upon mechanical stress only. Certain chemicals will significantly reduce maximum safe operating temperatures. Consult Chemical Resistance Guide for chemical compatibility and temperature limits.
-  **WARNING:** Prevention of static sparking — If static sparking occurs, fire or explosion could result. Pump, valves and containers must be grounded to a proper grounding point when handling flammable fluids and whenever discharge of static electricity is a hazard.
-  **CAUTION:** Do no exceed 8.6 bar (125 psig) air supply pressure [3.4 bar (50 psig) on UL Listed pumps].
-  **CAUTION:** The process fluid and cleaning fluids must be chemically compatible with all wetted pump components. Consult Chemical Resistance Guide.
-  **CAUTION:** Pumps should be thoroughly flushed before installing into process lines. FDA and USDA approved pumps should be cleaned and/or sanitized before being used.
-  **CAUTION:** Always wear safety glasses and appropriate safety equipment when operating pump. If diaphragm rupture occurs, material being pumped may be forced out air exhaust.
-  **CAUTION:** Before any maintenance or repair is attempted, the compressed air line to the pump should be disconnected and all air pressure allowed to bleed from pump. Disconnect all intake, discharge and air lines. Drain the pump by turning it upside down and allowing any fluid to flow into a suitable container.
-  **CAUTION:** Blow out air line for 10 to 20 seconds before attaching to pump to make sure all pipeline debris is clear. Use an in-line air filter. A 5µ (micron) air filter is recommended.
-  **NOTE:** When installing PTFE diaphragms, it is important to tighten outer pistons simultaneously (turning in opposite directions) to ensure tight fit. (See torque specifications in Section 7.)
-  **NOTE:** Cast Iron PTFE-fitted pumps come standard from the factory with expanded PTFE gaskets installed in the diaphragm bead of the liquid chamber. PTFE gaskets cannot be re-used.
-  **CAUTION:** When removing the end cap using compressed air, the air valve end cap may come out with considerable force. Hand protection such as a padded glove or rag should be used to capture the end cap.
-  **NOTE:** Before starting disassembly, mark a line from each liquid chamber to its corresponding air chamber. This line will assist in proper alignment during reassembly.
-  **CAUTION:** Tighten all hardware prior to installation.

WILDEN PUMP DESIGNATION SYSTEM

**T810 ADVANCED™
METAL**

**51 mm (2") Pump
Maximum Flow Rate:
628 lpm (166 gpm)**

LEGEND

T810 / XXXXX / XXX / XX / XXX / XXXX

MODEL

WETTED PARTS & OUTER PISTON
AIR CHAMBERS
CENTER BLOCK
AIR VALVE

CENTER BLOCK

AIR CHAMBERS

AIR VALVE

DIAPHRAGMS

FLAP VALVES

GASKETS

VALVE SEAT

SPECIALTY

CODE
(if applicable)

MATERIAL CODES

MODEL

810 = 51 mm (2") ADVANCED™
TOP INLET/BOTTOM
DISCHARGE

**WETTED PARTS
AND OUTER PISTON**

AM = ALUMINUM / MILD STEEL
WM = CAST IRON / MILD STEEL

AIR CHAMBERS

A = ALUMINUM

CENTER BLOCK

A = ALUMINUM

AIR VALVE

D = BRASS W/OIL BOTTLE

DIAPHRAGMS

BNS = BUNA-N (Red Dot)
NES = NEOPRENE (Green Dot)

FLAP VALVES

BF = BUNA (Red Dot)
NF = NEOPRENE (Green Dot)

VALVE SEAT

M = MILD STEEL

GASKETS

BN = BUNA-N (Red Dot)
NE = NEOPRENE (Green Dot)

SPECIALTY CODES

- 0677 Horizontal Center Ported, NPT Threaded
- 0678 Horizontal Center Ported, BSPT Threaded

NOTE: MOST ELASTOMERIC MATERIALS USE COLORED DOTS FOR IDENTIFICATION

HOW IT WORKS—PUMP

The Wilden diaphragm pump is an air-operated, positive displacement, self-priming pump. These drawings show flow pattern through the pump upon its initial stroke. It is assumed the pump has no fluid in it prior to its initial stroke.

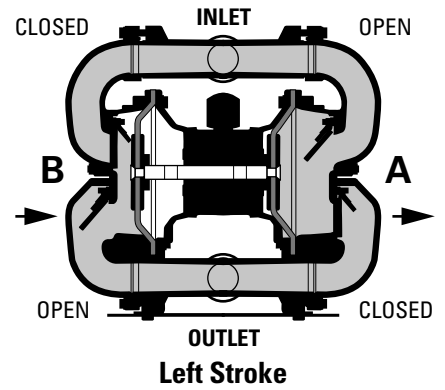
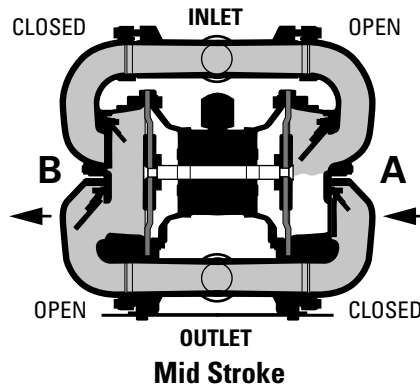
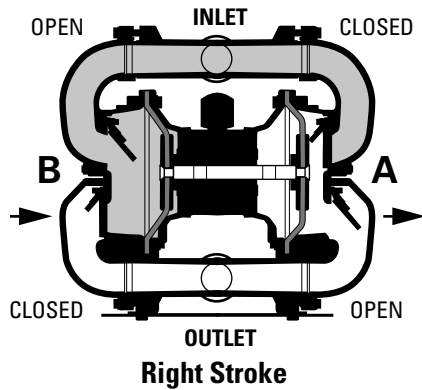

FIGURE 1 The air valve directs pressurized air to the back side of diaphragm A. The compressed air is applied directly to the liquid column separated by elastomeric diaphragms. The diaphragm acts as a separation membrane between the compressed air and liquid, balancing the load and removing mechanical stress from the diaphragm. The compressed air moves the diaphragm away from the center of the pump. The opposite diaphragm is pulled in by the shaft connected to the pressurized diaphragm. Diaphragm B is on its suction stroke; air behind the diaphragm has been forced out to atmosphere through the exhaust port of the pump. The movement of diaphragm B toward the center of the pump creates a vacuum within chamber B. Atmospheric pressure forces fluid into the inlet manifold forcing the inlet check valve off its seat. Liquid is free to move past the inlet check valve and fill the liquid chamber (see shaded area).

FIGURE 2 When the pressurized diaphragm, diaphragm A, reaches the limit of its discharge stroke, the air valve redirects pressurized air to the back side of diaphragm B. The pressurized air forces diaphragm B away from the center while pulling diaphragm A to the center. Diaphragm B is now on its discharge stroke. Diaphragm B forces the inlet check valve onto its seat due to the hydraulic forces developed in the liquid chamber and manifold of the pump. These same hydraulic forces lift the discharge check valve off its seat, while the opposite discharge check valve is forced onto its seat, forcing fluid to flow through the pump discharge. The movement of diaphragm A toward the center of the pump creates a vacuum within liquid chamber A. Atmospheric pressure forces fluid into the inlet manifold of the pump. The inlet check valve is forced off its seat allowing the fluid being pumped to fill the liquid chamber.

FIGURE 3 At completion of the stroke, the air valve again redirects air to the back side of diaphragm A, which starts diaphragm B on its suction stroke. As the pump reaches its original starting point, each diaphragm has gone through one suction and one discharge stroke. This constitutes one complete pumping cycle. The pump may take several cycles to completely prime depending on the conditions of the application.

NOTE: The fluid inlet of the Brahma Advanced™ pump is located at the top and the fluid discharge is located at the bottom of the pump.

HOW IT WORKS—AIR DISTRIBUTION SYSTEM

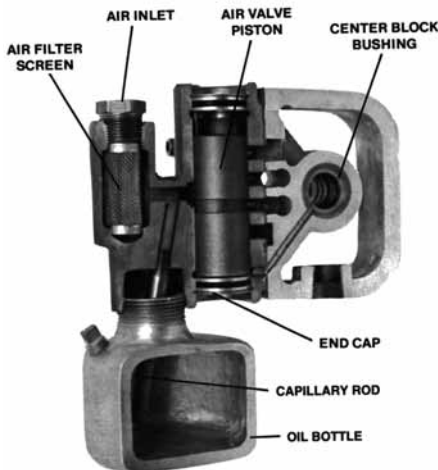

The Turbo-Flo™ air distribution system incorporates one moving part and consists of an air valve body, air valve piston and center block. The unique design of the air valve relies on differential pressure and works in conjunction with the center block bushing and the shaft/diaphragm assembly to direct pressurized air into one of the air chambers while exhausting the other. The air causes the shaft/diaphragm assembly to shift to one side – discharging liquid on that side and pulling liquid in on the other side. When the shaft/diaphragm assembly reaches the end of its stroke, the slots on the shaft align with the slots in the center block bushing “triggering” the air valve piston to shift in the air valve body. The repositioning of the air valve piston routes the pressurized air to the other air chamber.

DIMENSIONAL DRAWING

T810 ADVANCED™ METAL

DIMENSIONS

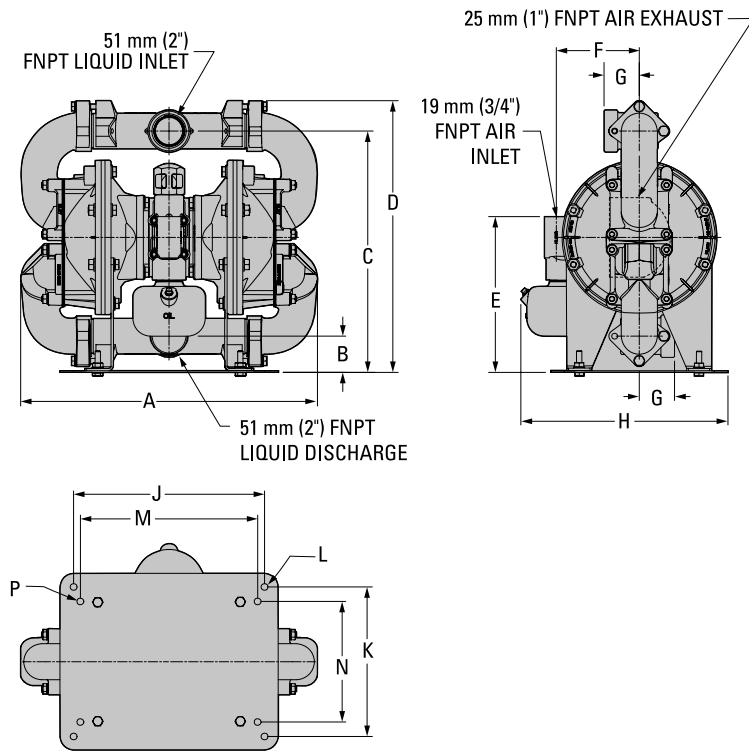

ITEM	METRIC (mm)	STANDARD (inch)
A	554	21.8
B	69	2.7
C	452	17.8
D	508	20.0
E	292	11.5
F	155	6.1
G	66	2.6
H	386	15.2
J	356	14.0
K	279	11.0
L	13	0.5
M	330	13.0
N	226	8.9
P	13	0.5

SUGGESTED INSTALLATION

Wilden pumps are designed to meet the performance requirements of even the most demanding pumping applications. They have been designed and manufactured to the highest standards and are available in a variety of wetted path materials to meet your chemical resistance needs. Refer to the performance section of this manual for an in-depth analysis of the performance characteristics of your pump. Wilden offers the widest variety of elastomer options in the industry to satisfy temperature, chemical compatibility, abrasion resistance and flex concerns.

The suction pipe size should be at least the equivalent or larger than the diameter size of the suction inlet on your Wilden pump. The suction hose must be non-collapsible, reinforced type as these pumps are capable of pulling a high vacuum. Discharge piping should also be the equivalent or larger than the diameter of the pump discharge which will help reduce friction losses. It is critical that all fittings and connections are airtight or a reduction or loss of pump suction capability will result.

INSTALLATION: Months of careful planning, study, and selection efforts can result in unsatisfactory pump performance if installation details are left to chance.

Premature failure and long term dissatisfaction can be avoided if reasonable care is exercised throughout the installation process.

LOCATION: Noise, safety and other logistical factors usually dictate where equipment will be situated on the production floor. Multiple installations with conflicting requirements can result in congestion of utility areas, leaving few choices for additional pumps.

Within the framework of these and other existing conditions, every pump should be located in such a way that six key factors are balanced against each other to maximum advantage.

ACCESS: First of all, the location should be accessible. If it's easy to reach the pump, maintenance personnel will have an easier time carrying out routine inspections and adjustments. Should major repairs become necessary, ease of access can play a key role in speeding the repair process and reducing total downtime.

AIR SUPPLY: Every pump location should have an air line large enough to supply the volume of air necessary to achieve the desired pumping rate. Use air pressure up to a maximum of 8.6 bar (125 psig) depending on pumping requirements.

For best results, the pumps should use a 5 μ (micron) air filter, needle valve and regulator. The use of an air filter before the pump will ensure that the majority of any pipeline contaminants will be eliminated.

SOLENOID OPERATION: When operation is controlled by a solenoid valve in the air line, three-way valves should be used. This valve allows trapped air between the valve and the pump to bleed off which improves pump performance. Pumping volume can be estimated by counting the number of strokes per minute and then multiplying the figure by the displacement per stroke.

MUFFLER: Sound levels are reduced below OSHA specifications using the standard Wilden muffler. Other mufflers can be used to further reduce sound levels, but

they usually reduce pump performance.

ELEVATION: Selecting a site that is well within the pump's dynamic lift capability will assure that loss-of-prime issues will be eliminated. In addition, pump efficiency can be adversely affected if proper attention is not given to site location.

PIPING: Final determination of the pump site should not be made until the piping challenges of each possible location have been evaluated. The impact of current and future installations should be considered ahead of time to make sure that inadvertent restrictions are not created for any remaining sites.

The best choice possible will be a site involving the shortest and straightest hook-up of suction and discharge piping. Unnecessary elbows, bends, and fittings should be avoided. Pipe sizes should be selected to keep friction losses within practical limits. All piping should be supported independently of the pump. In addition, the piping should be aligned to avoid placing stress on the pump fittings.

Flexible hose can be installed to aid in absorbing the forces created by the natural reciprocating action of the pump. If the pump is to be bolted down to a solid location, a mounting pad placed between the pump and the foundation will assist in minimizing pump vibration. Flexible connections between the pump and rigid piping will also assist in minimizing pump vibration. If quick-closing valves are installed at any point in the discharge system, or if pulsation within a system becomes a problem, a surge suppressor (SD Equalizer®) should be installed to protect the pump, piping and gauges from surges and water hammer.

If the pump is to be used in a self-priming application, make sure that all connections are airtight and that the suction lift is within the model's ability. Note: Materials of construction and elastomer material have an effect on suction lift parameters. Please refer to the performance section for specifics.

When pumps are installed in applications involving flooded suction or suction head pressures, a gate valve should be installed in the suction line to permit closing of the line for pump service.

Pumps in service with a positive suction head are most efficient when inlet pressure is limited to 0.5–0.7 bar (7–10 psig). Premature diaphragm failure may occur if positive suction is 0.7 bar (10 psig) and higher.

SUBMERSIBLE APPLICATIONS: Turbo-Flo™ pumps can be used for submersible applications. Pro-Flo V™ pumps can also be used for submersible applications.

NOTE: Accu-Flo™ pumps are not submersible.

ALL WILDEN PUMPS ARE CAPABLE OF PASSING SOLIDS. A STRAINER SHOULD BE USED ON THE PUMP INTAKE TO ENSURE THAT THE PUMP'S RATED SOLIDS CAPACITY IS NOT EXCEEDED.

CAUTION: DO NOT EXCEED 8.6 BAR (125 PSIG) AIR SUPPLY PRESSURE [3.4 BAR (50 PSIG) FOR UL LISTED MODELS].

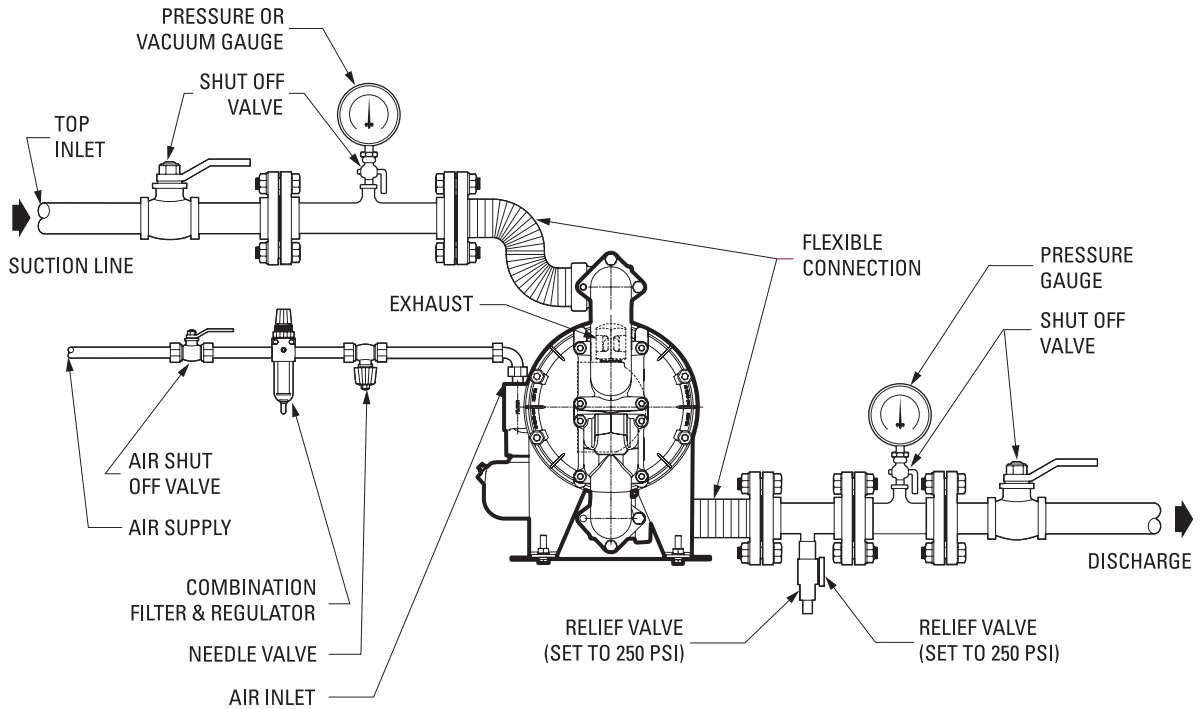

NOTE: In the event of a power failure, the shut off valve should be closed, if the restarting of the pump is not desirable once power is regained.

NOTE: The fluid inlet to the Brahma Advanced™ pump is located at the top and the fluid discharge is located at the bottom of the pump.

AIR OPERATED PUMPS: To stop the pump from operating in an emergency situation, simply close the shut off valve (user supplied) installed in the air supply line. A properly functioning valve will stop the air supply to the pump, therefore stopping output. This shut off valve should be located far enough away from the pumping equipment such that it can be reached safely in an emergency situation.

SUGGESTED OPERATION & MAINTENANCE

OPERATION: The Turbo-Flo™ pump is a non lube free pump and requires lubrication. Wilden suggests an arctic 5 weight oil (ISO grade 15). Do not over lubricate the pump. Excessive lubrication will not damage the pump but will reduce pump performance.

Pump discharge rate can be controlled by limiting the volume and/or pressure of the air supply to the pump. A regulator is used to control air pressure while a needle valve is used to control volume. Pump discharge rate can also be controlled by throttling the pump discharge by partially closing a valve in the discharge line of the pump. This action increases friction loss which reduces flow rate. (See Section 5.) This is useful when the need exists to control the pump from a remote location. When the pump discharge pressure equals or exceeds the air supply pressure, the pump will stop; no bypass or pressure relief valve is needed, and pump damage will not occur. The pump has reached a “deadhead” situation and can be restarted by reducing the fluid discharge pressure or increasing the air inlet pressure.

The Pro-Flo® and Pro-Flo V™ pumps run solely on compressed air and do not generate heat, therefore your process fluid temperature will not be affected.

MAINTENANCE AND INSPECTIONS: Since each application is unique, maintenance schedules may be different for every pump. Frequency of use, line pressure, viscosity and abrasiveness of process fluid all affect the parts life of a Wilden pump. Periodic inspections have been found to offer the best means for preventing unscheduled pump downtime. Personnel familiar with the pump’s construction and service should be informed of any abnormalities that are detected during operation.

RECORDS: When service is required, a record should be made of all necessary repairs and replacements. Over a period of time, such records can become a valuable tool for predicting and preventing future maintenance problems and unscheduled downtime. In addition, accurate records make it possible to identify pumps that are poorly suited to their applications.

TROUBLESHOOTING

Pump will not run or runs slowly.

1. Check air inlet screen and air filter for debris.
2. Disassemble the pump and check for objects which would obstruct the movement of the internal parts.
3. Check for sticking air valve piston. If air valve piston doesn’t move freely, flush air valve with solvent.
4. Check for extreme air leakage (blow by) which would indicate worn air valve or worn main shaft seals.
5. Check for loose outer piston.
6. Check type of lubricant being used. A higher viscosity oil than suggested may cause the piston to stick or run erratically. Wilden suggests the use of an oil with arctic characteristics (ISO 15-5 wt.).

Pump runs but little or no product flows.

1. Check for pump cavitation; slow pump speed down to allow thick material to flow into liquid chambers.
2. Verify that vacuum required to lift liquid is not greater than the vapor pressure of the material being pumped (cavitation).
3. Check for sticking check valves. If material being pumped is not compatible with pump elastomers,

swelling may occur. Replace check valves with proper elastomers.

Pump air valve freezes.

1. Check for excessive moisture in compressed air. Either install a dryer or hot air generator for compressed air. Alternatively, a coalescing filter may be used to remove the water from the compressed air in some applications.

Air bubbles in pump discharge.

1. Check for ruptured diaphragm.
2. Check tightness of outer pistons (refer to Section 7).
3. Check tightness of fasteners and integrity of o-rings and seals, especially at intake manifold.
4. Ensure pipe connections are airtight.

Product comes out air exhaust.

1. Check for diaphragm rupture.
2. Check tightness of outer pistons to shaft.

PUMP DISASSEMBLY

TOOLS REQUIRED:

- 6 mm hex head wrench
- 10 mm box wrench
- 10 mm hex head wrench
- 17 mm box wrench
- 19 mm box wrench
- 5/16" hex head wrench
- O-ring pick
- Adjustable wrench

CAUTION: Before any maintenance or repair is attempted, the compressed air line to the pump should be disconnected and all air pressure allowed to bleed from the pump. Disconnect all intake, discharge and air lines. Drain the pump by turning it upside down and allowing any fluid to flow into a suitable container. Be aware of any hazardous effects of contact with your process fluid.

**Step 1**

Before starting disassembly, mark a line from each liquid chamber to corresponding air chamber. This will assist in proper alignment during reassembly.

**Step 2**

Using a 17 mm wrench, remove the fasteners that connect the inlet elbow to the inlet T-section.

**Step 3**

Using a 17 mm wrench, remove the fastener that connects the inlet elbow to the liquid chamber.

PUMP DISASSEMBLY



Step 4

Next, remove the inlet elbow from the liquid chamber.



Step 5

Using a 10 mm wrench, remove the flap valve assembly from the inlet elbow. Inspect flap valves for nicks, gouges, chemical attack or abrasive wear. Note: replace worn parts with genuine Wilden parts for reliable performance.



Step 6

Inspect manifold gasket, flap valve seat and seat gasket for nicks, gouges, chemical attack or abrasive wear.



Step 7

Using a 17 mm wrench, remove the fasteners that connect the remaining inlet elbow to the inlet T-section.



Step 8

Using a 17 mm wrench, remove the fasteners that connect the remaining inlet elbow to the liquid chamber.



Step 9

Next, remove the remaining inlet elbow from the liquid chamber.



Step 10

Using a 17 mm wrench, remove the fasteners that connect the discharge elbow to the discharge T-section. To simplify this process, a socket extension can be used for easier access to the fastener.



Step 11

Using a 17 mm wrench, remove the fasteners that connect the discharge elbow to the liquid chamber.

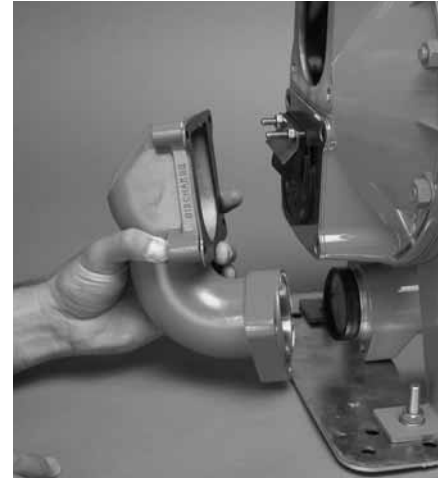

Step 12

Next, remove the discharge elbow from the liquid chamber.



Step 13

Using a 10 mm wrench, remove the flap valve assembly from the liquid chamber. Inspect flap valves for nicks, gouges, chemical attack or abrasive wear. Note: replace worn parts with genuine Wilden parts for reliable performance.



Step 14

Inspect manifold gasket, flap valve seat and seat gasket for nicks, gouges, chemical attack or abrasive wear.

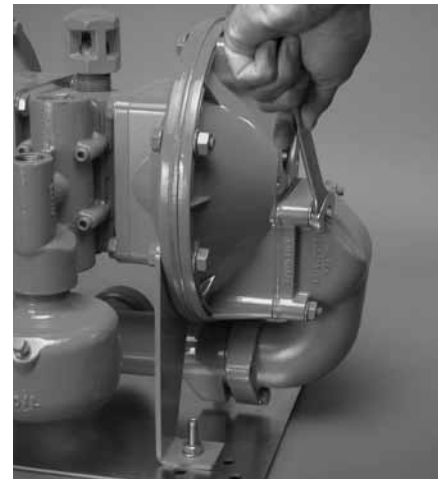

Step 15

Using a 17 mm wrench, remove the fasteners that connect the remaining discharge elbow to the liquid chamber.

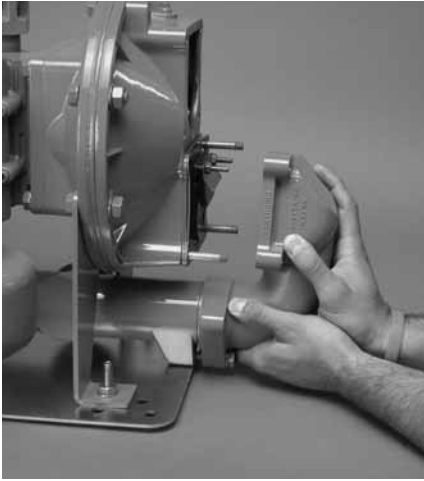

Step 16

Remove the discharge elbow and discharge T-section from the liquid chamber. This will allow for easy removal of the flap valve assembly. Inspect for nicks, gouges, chemical attack or abrasive wear.



Step 17

Using a 19 mm wrench, remove the fasteners that connect the liquid chambers to the center section.



Step 18

Remove the liquid chamber to expose the diaphragm and outer piston.

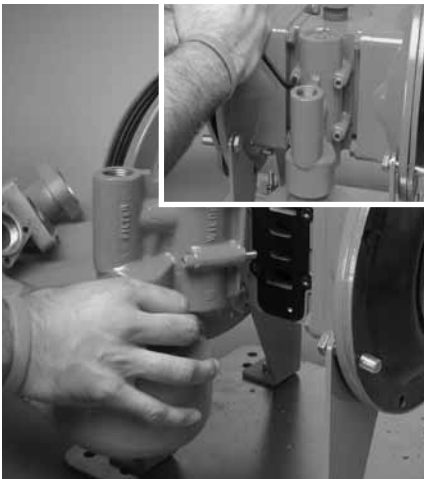

Step 19

Using a 5/16" hex head wrench, remove fasteners that connect the air valve to the center section. Inspect air valve gasket and replace if necessary.

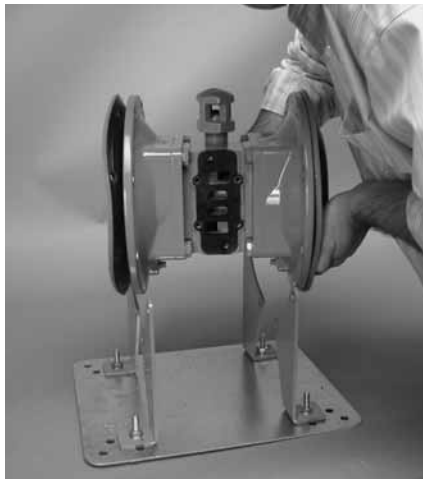

Step 20

Next, remove center section assembly from pump stand.



Step 21

Using two 10 mm hex head wrenches, loosen the outer piston from the main shaft.

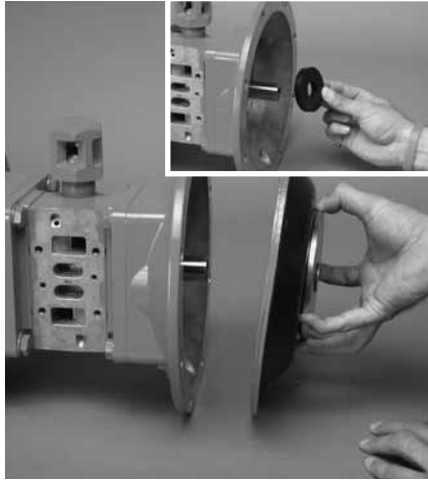

Step 22

After loosening the outer piston from the main shaft, the diaphragm/piston assembly and bumper can be removed from the center section.

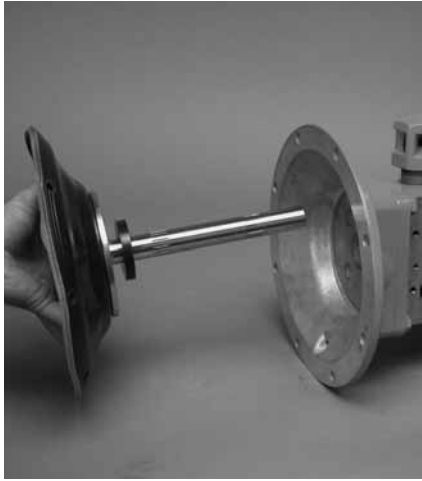

Step 23

Next, remove the remaining diaphragm/piston assembly, bumper and main shaft from the center section.



Step 24

Remove the inner piston from the diaphragm/piston assembly by turning counterclockwise.



Step 25

Using a 6 mm hex head wrench, loosen the fasteners that connect the air chamber to the center block by turning counterclockwise.



Step 26

Remove the air chamber to expose the center block gasket. Inspect and replace if necessary.

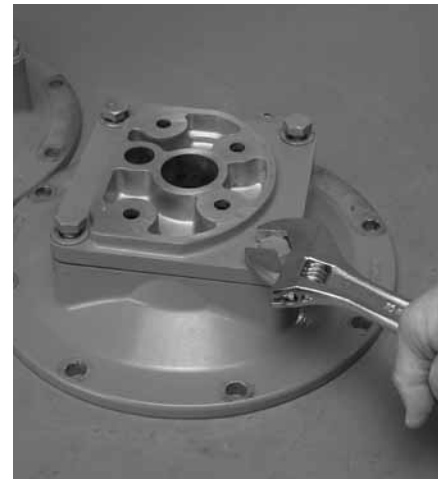

Step 27

Using an adjustable wrench, remove the fasteners that connect the center block adapter plate to the air chamber.

PUMP DISASSEMBLY



Step 28

Remove the center block adapter plate from the air chamber.

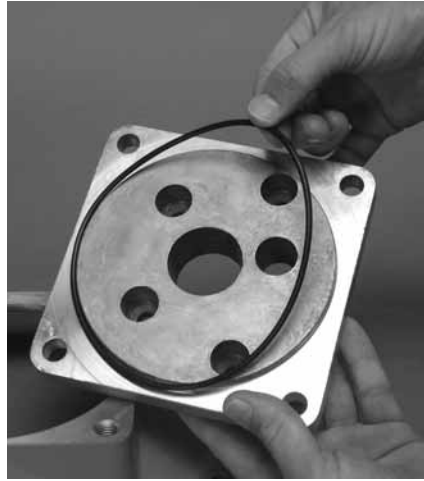

Step 29

Next, remove the center block adapter plate o-ring and inspect for nicks, gouges, chemical attack or abrasive wear.

AIR VALVE / CENTER SECTION DISASSEMBLY

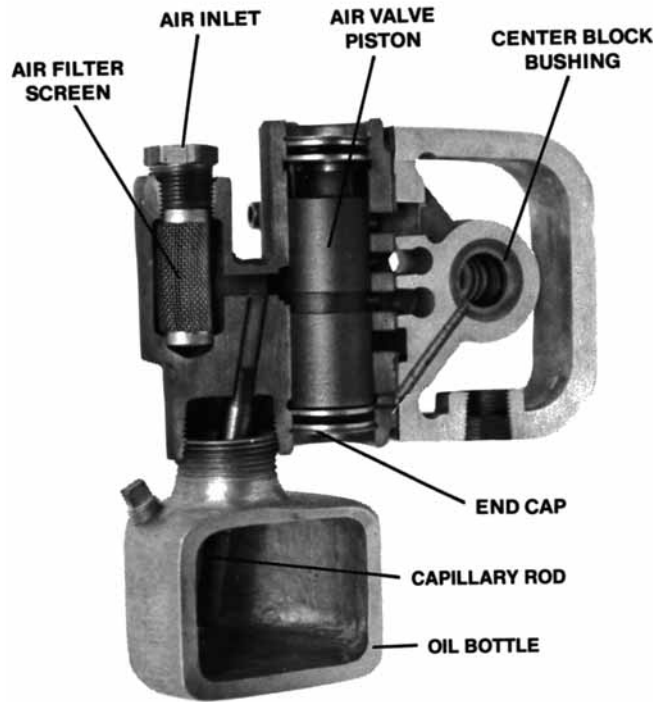

The air valve assembly consists of both the air valve body and piston and the center block. The unique design of the air valve relies on differential pressure to effect the diaphragm shift. It is reliable and simple to maintain. The bushing in the center block, along with the diaphragm shaft, provides the “trigger” to tell the air valve to shift. The following procedure will ensure that the air valve on your Wilden pump will provide long-lasting trouble-free service.

Air Valve Body And Piston Assembly And Disassembly:

The air valve body and piston can be disconnected from the pump by removing the four socket head cap screws which attach it to the center block. The piston in the air valve is aluminum with a dark gray anodized coating. The piston should move freely and the ports in the piston should line up with the ports on the face of the air valve body (see figure A). The piston should also appear to be a dull, dark gray in color. If the piston appears to be a shiny aluminum color, the air valve is probably worn beyond working tolerance and should be replaced.

If the piston does not move freely in the air valve, the entire air valve should be immersed in a cleaning solution.

[NOTE: Do not force the piston by inserting a metal object.] This soaking should remove any accumulation of sludge and grit which is preventing the air valve piston from moving freely. Also, remove and clean the air valve screen. If the air valve piston does not move freely after the above cleaning, the air valve should be disassembled as follows: remove the snap ring from the top end of the air valve cylinder and apply an air jet to the 3/16-inch hole on the opposite end of the air valve face (see figure B). **CAUTION:** The air valve end cap may come out with considerable force. Hand protection such as a padded glove or rag should be used to capture the end cap.

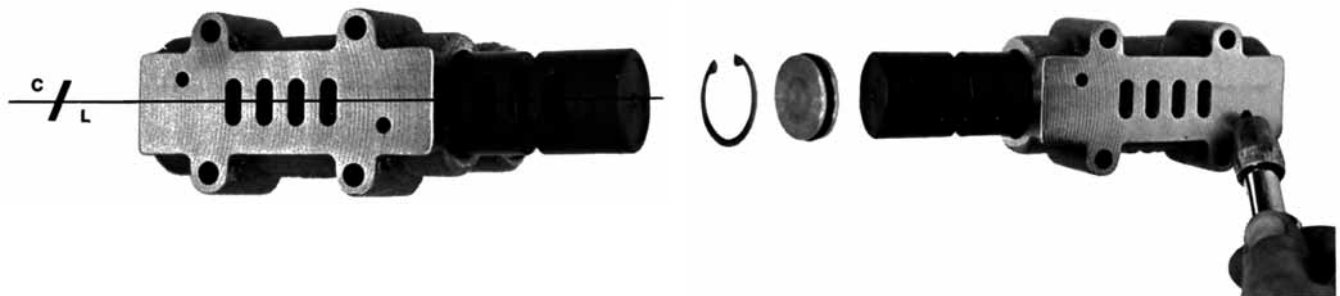

Figure A

Figure B

AIR VALVE / CENTER SECTION DISASSEMBLY

Small nicks can usually be dressed out and the piston returned to service. Make sure that the guide pin is straight and smooth or the piston will not move freely in the cylinder. Clean out anti-centering pin holes located at each side of the piston. Pin holes are located on each side of the annular groove on the top of the piston and travel to each end. New o-rings should be installed on the end caps. Lubricate the o-rings and install the end caps, assuring that proper alignment of the piston and cylinder ports are maintained (see figure A, previous page). Reinstall air valve to center block of pump.

Glyd™ Ring Replacement:

When the Glyd™ rings become worn, they will no longer seal and must be replaced.

Center Block Assembly:

The pump's center block consists of a die cast housing with a cast-in bronze bushing (see figure C). The bushing has eleven grooves cut on the inside diameter. There are seven Glyd™ rings that fit into these grooves (see figure D). Since these Glyd™ rings form a part of the shifting function of the pump, it is necessary that they be located in the proper grooves. When bushing wear becomes excessive, a new center block must be used.



Figure C
(Side View)

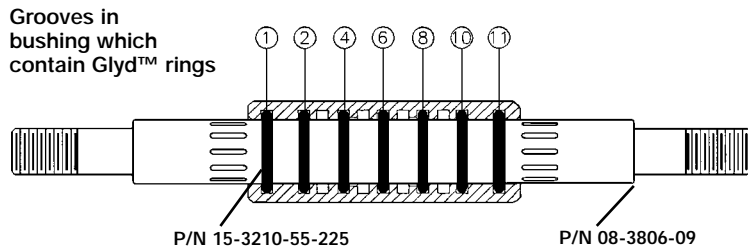

Figure D

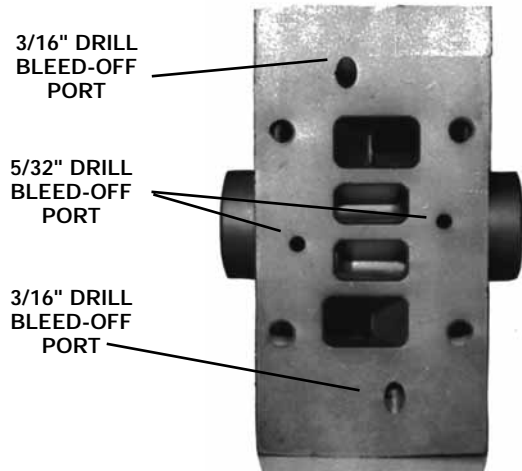

Figure E
Center Block (Front View)

REASSEMBLY HINTS & TIPS

ASSEMBLY:

Upon performing applicable maintenance to the air distribution system, the pump can now be reassembled. Please refer to the disassembly instructions for photos and parts placement. To reassemble the pump, follow the disassembly instructions in reverse order. The air distribution system needs to be assembled first, then the diaphragms and finally the wetted path. Please find the applicable torque specifications on this page. The following tips will assist in the assembly process.

- Clean the inside of the center section shaft bushing to ensure no damage is done to new shaft seals.
- Remove the air chamber from the center block assembly prior to removing the center block adapter plate from the air chamber.
- When reassembling the pump, leave wetted path fasteners somewhat loose until all wetted components are installed. This will simplify proper wetted component joint alignment and will ensure proper sealing.
- Stainless steel bolts should be lubed to reduce the possibility of seizing during tightening.

SHAFT SEAL INSTALLATION:

Pre-installation

- Once all of the old seals have been removed, the inside of the bushing should be cleaned to ensure no debris is left that may cause premature damage to the new seals.

T810 MAXIMUM TORQUE SPECIFICATIONS

Description of Part	Torque
Air Valve	9.0 N•m (80 in-lbs)
Center Block Assembly	27.1 N•m (20 ft-lbs)
Center Block Adapter Plate to Air Chamber	3.8 N•m (34 ft-lbs)
Outer Piston	4.5 N•m (40 ft-lbs)
Flap Valve Assembly	1.7 N•m (15 in-lbs)
Liquid Chamber to Air Chamber	2.7 N•m (24 ft-lbs)
Manifold Elbow to Liquid Chamber	2.0 N•m (18 ft-lbs)
Manifold Elbow to T-Section	1.7 N•m (15 ft-lbs)

Figure A

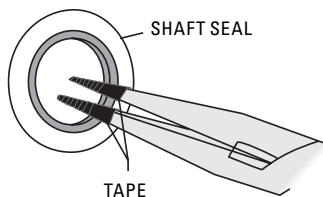

INSTALLATION

The following tools can be used to aid in the installation of the new seals:

- Needle Nose Pliers
- Phillips Screwdriver
- Electrical Tape

- Wrap electrical tape around each leg for the needle nose pliers (heat shrink tubing may also be used). This is done to prevent damage to the inside surface of the seal.
- With a new seal in hand, place the two prongs of the needle nose pliers inside the seal ring (see figure A).
- Open the pliers as wide as the seal diameter will allow, then with two fingers pull down on the top portion of the seal to form a kidney shape (see figure B).
- Lightly clamp the pliers together to hold the seal into the kidney shape. Be sure to pull the seal into as tight of a kidney shape as possible. This will allow the seal to travel down the bushing bore easier.
- With the seal clamped in the needle nose pliers, insert the seal into the bushing bore and position the bottom of the seal into the correct groove. Once the bottom of the seal is seated in the groove, release the clamp pressure on the pliers. This will allow the seal to partially snap back to its original shape.
- Slowly insert the shaft with a rotating motion. This will allow complete the resizing of the seal.
- Perform these steps for the remaining seals.

Figure B

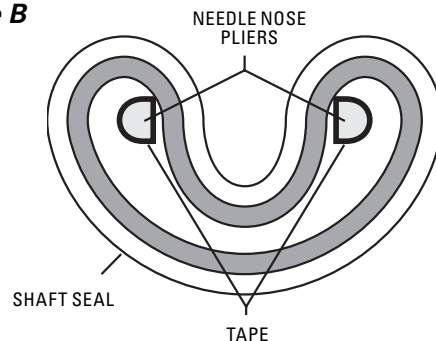

EXPLODED VIEW AND PARTS LISTING

T810 ADVANCED METAL

Wetted Path

EXPLODED VIEW

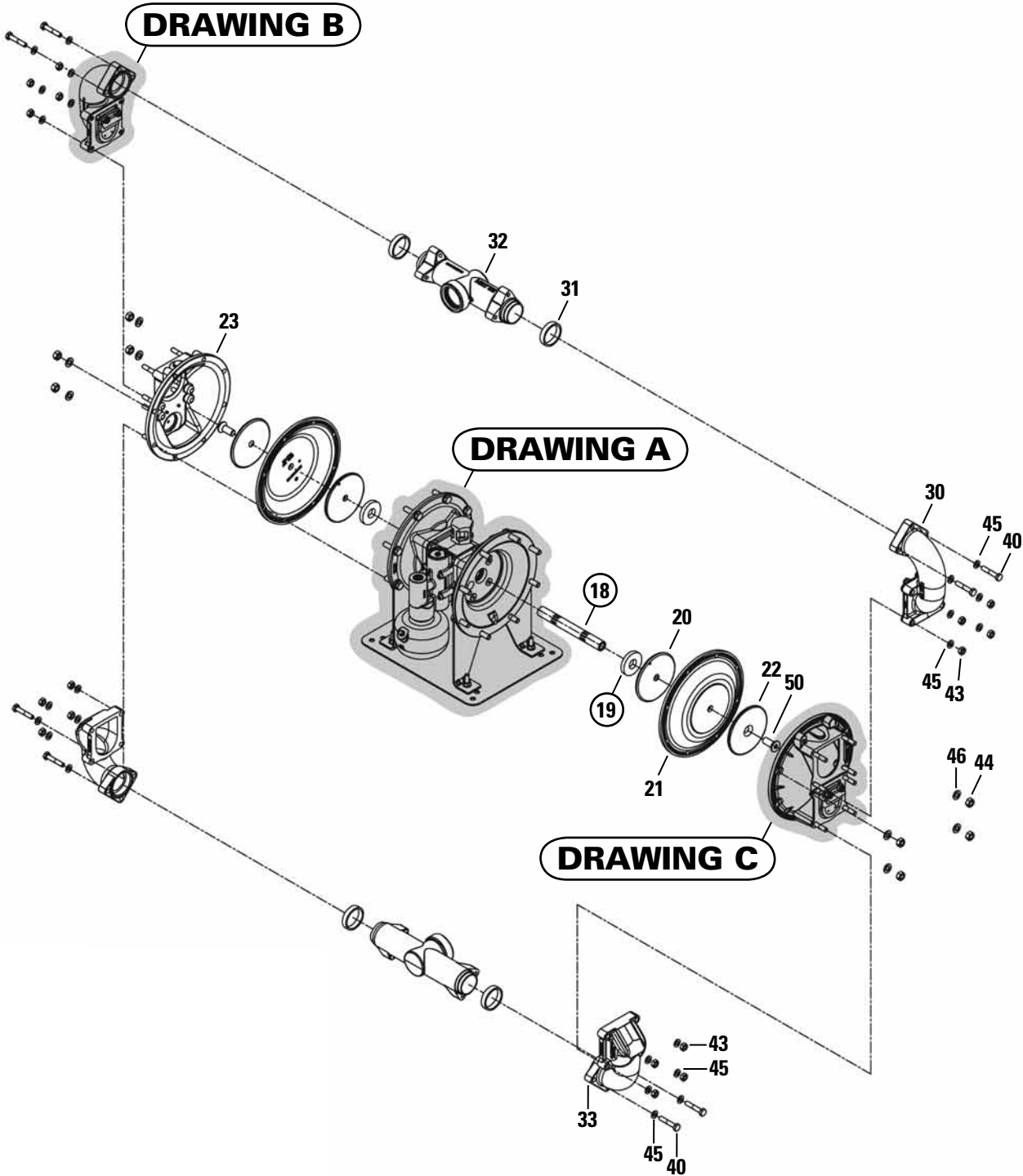

ALL CIRCLED PART IDENTIFIERS ARE INCLUDED IN CONVERSION KIT (see section 9).

EXPLODED VIEW AND PARTS LISTING

T810 ADVANCED METAL

Wetted Path

PARTS LISTING

Item	Description	Qty.	T810/ AAAD/.../677 P/N	T810/ WWAAD/.../677 P/N	T810/ AAAD/.../678 P/N	T810/ WWAAD/.../678 P/N
1	Assembly, Air Valve ¹	1	15-2080-07	15-2080-07	15-2080-07	15-2080-07
2	Screen, Air Valve	1	08-2500-07	08-2500-07	08-2500-07	08-2500-07
3	Cap (with Guide), Air Valve Body End	1	15-2300-23	15-2300-23	15-2300-23	15-2300-23
4	Cap (without Guide), Air Valve Body End	1	15-2330-23	15-2330-23	15-2330-23	15-2330-23
5	Ring, Retaining	2	15-2650-03	15-2650-03	15-2650-03	15-2650-03
6	O-ring	2	15-2390-52	15-2390-52	15-2390-52	15-2390-52
7	Bottle, Oil	1	15-2850-01	15-2850-01	15-2850-01	15-2850-01
8	Plug, ¼ NPT	1	08-7000-07	08-7000-07	08-7000-07	08-7000-07
9	Assembly, Capillary Rod	1	15-2900-99	15-2900-99	15-2900-99	15-2900-99
10	Gasket, Air Valve	1	15-2600-52	15-2600-52	15-2600-52	15-2600-52
11	Screw, 5/16-18 x 2¼ SHC	4	08-6000-08	08-6000-08	08-6000-08	08-6000-08
12	Center Block	1	15-3100-01-225	15-3100-01-225	15-3100-01-225	15-3100-01-225
13	Shaft Seal	7	15-3210-55-225	15-3210-55-225	15-3210-55-225	15-3210-55-225
14	Gasket, Center Block	2	15-3528-52	15-3528-52	15-3528-52	15-3528-52
15	Plate, Center Block Adapter	2	08-3880-01	08-3880-01	08-3880-01	08-3880-01
16	O-Ring	2	08-3025-52	08-3025-52	08-3025-52	08-3025-52
17	Chamber, Air	2	08-3665-01	08-3665-01	08-3665-01	08-3665-01
18	Shaft	1	08-3806-09	08-3806-09	08-3806-09	08-3806-09
19	Bumper	2	08-6902-52	08-6902-52	08-6902-52	08-6902-52
20	Piston, Inner	2	08-3705-08	08-3705-08	08-3705-08	08-3705-08
21	Diaphragm, Flap Valve	2	*	*	*	*
22	Piston, Outer	2	08-4555-08	08-4555-08	08-4555-08	08-4555-08
23	Chamber, Liquid	2	08-4985-01	08-4985-02	08-4985-01	08-4985-02
24	Gasket, Seat	4	*	*	*	*
25	Seat, Flap Valve	4	08-1150-08	08-1150-08	08-1150-08	08-1150-08
26	Gasket, Manifold	4	*	*	*	*
27	Valve, Flap	4	*	*	*	*
28	Pad, Flap Valve Hinge	4	*	*	*	*
29	Retainer, Flap Valve	4	08-1196-08	08-1196-08	08-1196-08	08-1196-08
30	Elbow, Inlet	2	08-5215-01	08-5215-02	08-5215-01	08-5215-02
31	Ring, Manifold Sealing	4	*	*	*	*
32	T-Section	2	08-5175-01	08-5175-02	08-5175-01-14	08-5175-02-14
33	Elbow, Discharge	2	08-5255-01	08-5255-02	08-5255-01	08-5255-02
34	Left - Hand Foot	2	08-5546-08	08-5546-08	08-5546-08	08-5546-08
35	Right - Hand Foot	2	08-5545-08	08-5545-08	08-5545-08	08-5545-08
36	Plate, Base	1	08-5550-08	08-5550-08	08-5550-08	08-5550-08
37	Stud, 1/4-20 x 1.50 Threaded	8	08-6162-08	08-6162-08	08-6162-08	08-6162-08
38	Stud, 3/8-16 x 2.50 Threaded	16	08-6161-08	08-6161-08	08-6161-08	08-6161-08
39	Screw, 3/8-16 x 1.56 HHC	4	08-6362-08	08-6362-08	08-6362-08	08-6362-08
40	Screw, 3/8-16 x 2.16 HHC	8	08-6184-08	08-6184-08	08-6184-08	08-6184-08
41	Screw, 7/16-14 x 1.18 HHC	8	08-6195-08	08-6195-08	08-6195-08	08-6195-08
42	Screw, 7/16-14 x 1.75 HHC	16	08-6194-08	08-6194-08	08-6194-08	08-6194-08
43	Nut, 3/8-16 Hex	20	02-6430-08	02-6430-08	02-6430-08	02-6430-08
44	Nut, 7/16-14 Hex	8	08-6427-08	08-6427-08	08-6427-08	08-6427-08
45	Washer, 3/8 Plain	28	15-6740-08-50	15-6740-08-50	15-6740-08-50	15-6740-08-50
46	Washer, 7/16 Plain ³	32	08-6734-08	08-6734-08	08-6734-08	08-6734-08
47	Nut, 1/4-20 Lock Hex	8	08-6477-08	08-6477-08	08-6477-08	08-6477-08
48	Nut, 3/8-16 Cone	4	08-6550-08	08-6550-08	08-6550-08	08-6550-08
49	Screw, 3/8-16 x 5.50 SFCHC	4	08-6231-08	08-6231-08	08-6231-08	08-6231-08
50	Screw, 5/8-18 x 1.56 SFCHC	2	08-6092-08	08-6092-08	08-6092-08	08-6092-08
51	Nipple, 1 NPT Close	1	15-7420-08	15-7420-08	15-7420-08	15-7420-08
52	Check, Ball	1	15-1450-51	15-1450-51	15-1450-51	15-1450-51
53	Body, Exhaust Check Valve	1	15-3550-01	15-3550-01	15-3550-01	15-3550-01
54	Muffler Kit – OPTIONAL ²	1	15-3515-99	15-3515-99	15-3515-99	15-3515-99

*Refer to Elastomer Options in Section 9

¹Air Valve Assembly includes items 1 through 9

²Replaces items 51, 52 & 53 if this option is selected

³T810 Conversion kit (08-9670-01) contains 8 pcs.

All boldface items are primary wear parts.

*All circled items included in T810 Conversion Kit P/N 08-9670-01

677 Specialty Code = Horizontal Center Ported, NPT Threaded

678 Specialty Code = Horizontal Center Ported, BSPT Threaded

EXPLODED VIEW AND PARTS LISTING

T810 ADVANCED METAL

Center Section Assembly

EXPLODED VIEW

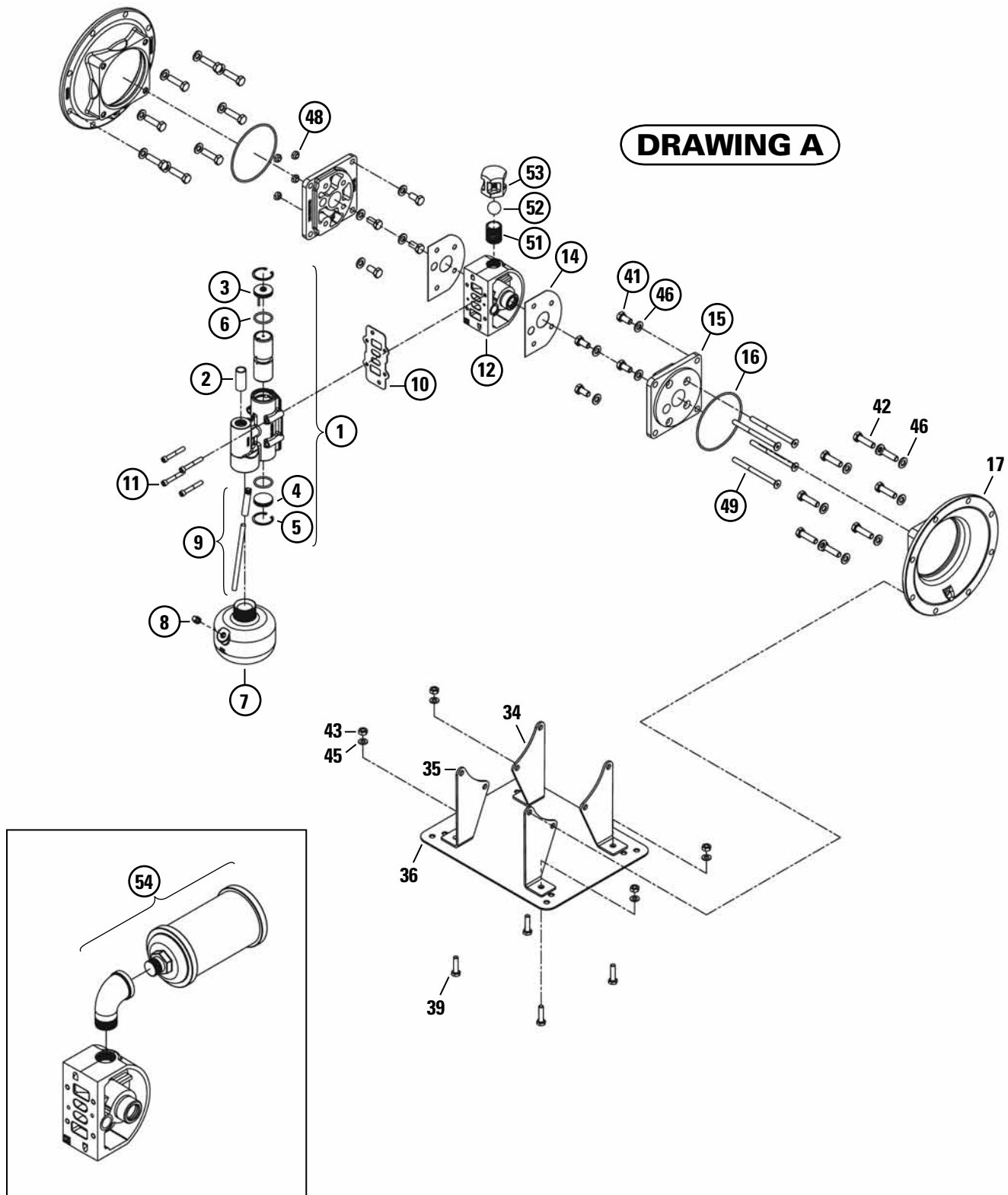

ALL CIRCLED PART IDENTIFIERS ARE INCLUDED IN CONVERSION KIT (see section 9).

EXPLODED VIEW AND PARTS LISTING

T810 ADVANCED METAL | **Center Section Assembly** | **PARTS LISTING**

Item	Description	Qty.	T810/	T810/	T810/	T810/
			AAAAD/.../677	WWAAD/.../677	AAAAD/.../678	WWAAD/.../678
			P/N	P/N	P/N	P/N
1	Assembly, Air Valve¹	1	15-2080-07	15-2080-07	15-2080-07	15-2080-07
2	Screen, Air Valve	1	08-2500-07	08-2500-07	08-2500-07	08-2500-07
3	Cap (with Guide), Air Valve Body End	1	15-2300-23	15-2300-23	15-2300-23	15-2300-23
4	Cap (without Guide), Air Valve Body End	1	15-2330-23	15-2330-23	15-2330-23	15-2330-23
5	Ring, Retaining	2	15-2650-03	15-2650-03	15-2650-03	15-2650-03
6	O-ring	2	15-2390-52	15-2390-52	15-2390-52	15-2390-52
7	Bottle, Oil	1	15-2850-01	15-2850-01	15-2850-01	15-2850-01
8	Plug, ¼ NPT	1	08-7000-07	08-7000-07	08-7000-07	08-7000-07
9	Assembly, Capillary Rod	1	15-2900-99	15-2900-99	15-2900-99	15-2900-99
10	Gasket, Air Valve	1	15-2600-52	15-2600-52	15-2600-52	15-2600-52
11	Screw, 5/16-18 x 2¼ SHC	4	08-6000-08	08-6000-08	08-6000-08	08-6000-08
12	Center Block	1	15-3100-01-225	15-3100-01-225	15-3100-01-225	15-3100-01-225
13	Shaft Seal	7	15-3210-55-225	15-3210-55-225	15-3210-55-225	15-3210-55-225
14	Gasket, Center Block	2	15-3528-52	15-3528-52	15-3528-52	15-3528-52
15	Plate, Center Block Adapter	2	08-3880-01	08-3880-01	08-3880-01	08-3880-01
16	O-Ring	2	08-3025-52	08-3025-52	08-3025-52	08-3025-52
17	Chamber, Air	2	08-3665-01	08-3665-01	08-3665-01	08-3665-01
18	Shaft	1	08-3806-09	08-3806-09	08-3806-09	08-3806-09
19	Bumper	2	08-6902-52	08-6902-52	08-6902-52	08-6902-52
20	Piston, Inner	2	08-3705-08	08-3705-08	08-3705-08	08-3705-08
21	Diaphragm, Flap Valve	2	*	*	*	*
22	Piston, Outer	2	08-4555-08	08-4555-08	08-4555-08	08-4555-08
23	Chamber, Liquid	2	08-4985-01	08-4985-02	08-4985-01	08-4985-02
24	Gasket, Seat	4	*	*	*	*
25	Seat, Flap Valve	4	08-1150-08	08-1150-08	08-1150-08	08-1150-08
26	Gasket, Manifold	4	*	*	*	*
27	Valve, Flap	4	*	*	*	*
28	Pad, Flap Valve Hinge	4	*	*	*	*
29	Retainer, Flap Valve	4	08-1196-08	08-1196-08	08-1196-08	08-1196-08
30	Elbow, Inlet	2	08-5215-01	08-5215-02	08-5215-01	08-5215-02
31	Ring, Manifold Sealing	4	*	*	*	*
32	T-Section	2	08-5175-01	08-5175-02	08-5175-01-14	08-5175-02-14
33	Elbow, Discharge	2	08-5255-01	08-5255-02	08-5255-01	08-5255-02
34	Left - Hand Foot	2	08-5546-08	08-5546-08	08-5546-08	08-5546-08
35	Right - Hand Foot	2	08-5545-08	08-5545-08	08-5545-08	08-5545-08
36	Plate, Base	1	08-5550-08	08-5550-08	08-5550-08	08-5550-08
37	Stud, 1/4-20 x 1.50 Threaded	8	08-6162-08	08-6162-08	08-6162-08	08-6162-08
38	Stud, 3/8-16 x 2.50 Threaded	16	08-6161-08	08-6161-08	08-6161-08	08-6161-08
39	Screw, 3/8-16 x 1.56 HHC	4	08-6362-08	08-6362-08	08-6362-08	08-6362-08
40	Screw, 3/8-16 x 2.16 HHC	8	08-6184-08	08-6184-08	08-6184-08	08-6184-08
41	Screw, 7/16-14 x 1.18 HHC	8	08-6195-08	08-6195-08	08-6195-08	08-6195-08
42	Screw, 7/16-14 x 1.75 HHC	16	08-6194-08	08-6194-08	08-6194-08	08-6194-08
43	Nut, 3/8-16 Hex	20	02-6430-08	02-6430-08	02-6430-08	02-6430-08
44	Nut, 7/16-14 Hex	8	08-6427-08	08-6427-08	08-6427-08	08-6427-08
45	Washer, 3/8 Plain	28	15-6740-08-50	15-6740-08-50	15-6740-08-50	15-6740-08-50
46	Washer, 7/16 Plain ³	32	08-6734-08	08-6734-08	08-6734-08	08-6734-08
47	Nut, 1/4-20 Lock Hex	8	08-6477-08	08-6477-08	08-6477-08	08-6477-08
48	Nut, 3/8-16 Cone	4	08-6550-08	08-6550-08	08-6550-08	08-6550-08
49	Screw, 3/8-16 x 5.50 SFCHC	4	08-6231-08	08-6231-08	08-6231-08	08-6231-08
50	Screw, 5/8-18 x 1.56 SFCHC	2	08-6092-08	08-6092-08	08-6092-08	08-6092-08
51	Nipple, 1 NPT Close	1	15-7420-08	15-7420-08	15-7420-08	15-7420-08
52	Check, Ball	1	15-1450-51	15-1450-51	15-1450-51	15-1450-51
53	Body, Exhaust Check Valve	1	15-3550-01	15-3550-01	15-3550-01	15-3550-01
54	Muffler Kit – OPTIONAL ²	1	15-3515-99	15-3515-99	15-3515-99	15-3515-99

*Refer to Elastomer Options in Section 9
¹Air Valve Assembly includes items 1 through 9
²Replaces items 51, 52 & 53 if this option is selected
³T810 Conversion kit (08-9670-01) contains 8 pcs.

All boldface items are primary wear parts.
 *All circled items included in T810 Conversion Kit P/N 08-9670-01
 677 Specialty Code = Horizontal Center Ported, NPT Threaded
 678 Specialty Code = Horizontal Center Ported, BSPT Threaded

EXPLODED VIEW AND PARTS LISTING

T810 ADVANCED METAL

Flap Assemblies

EXPLODED VIEW

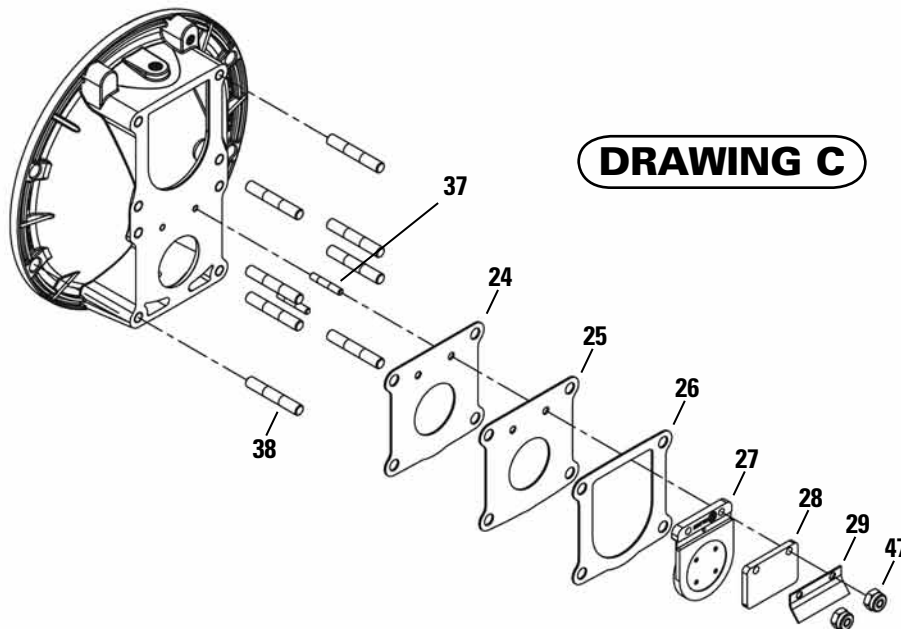
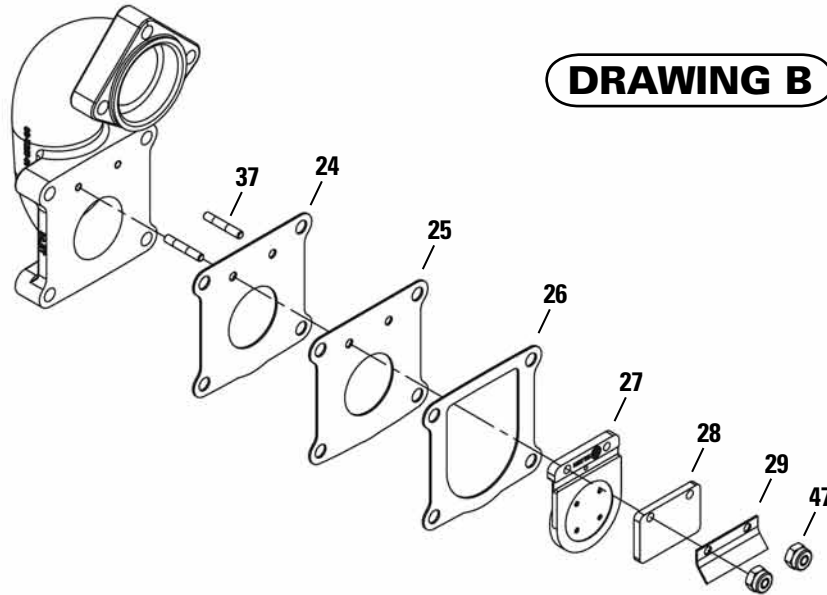

EXPLODED VIEW AND PARTS LISTING

T810 ADVANCED METAL

Flap Assemblies

PARTS LISTING

Item	Description	Qty.	T810/	T810/	T810/	T810/
			AAAAD/.../677 P/N	WWAAD/.../677 P/N	AAAAD/.../678 P/N	WWAAD/.../678 P/N
1	Assembly, Air Valve ¹	1	15-2080-07	15-2080-07	15-2080-07	15-2080-07
2	Screen, Air Valve	1	08-2500-07	08-2500-07	08-2500-07	08-2500-07
3	Cap (with Guide), Air Valve Body End	1	15-2300-23	15-2300-23	15-2300-23	15-2300-23
4	Cap (without Guide), Air Valve Body End	1	15-2330-23	15-2330-23	15-2330-23	15-2330-23
5	Ring, Retaining	2	15-2650-03	15-2650-03	15-2650-03	15-2650-03
6	O-ring	2	15-2390-52	15-2390-52	15-2390-52	15-2390-52
7	Bottle, Oil	1	15-2850-01	15-2850-01	15-2850-01	15-2850-01
8	Plug, ¼ NPT	1	08-7000-07	08-7000-07	08-7000-07	08-7000-07
9	Assembly, Capillary Rod	1	15-2900-99	15-2900-99	15-2900-99	15-2900-99
10	Gasket, Air Valve	1	15-2600-52	15-2600-52	15-2600-52	15-2600-52
11	Screw, 5/16-18 x 2¼ SHC	4	08-6000-08	08-6000-08	08-6000-08	08-6000-08
12	Center Block	1	15-3100-01-225	15-3100-01-225	15-3100-01-225	15-3100-01-225
13	Shaft Seal	7	15-3210-55-225	15-3210-55-225	15-3210-55-225	15-3210-55-225
14	Gasket, Center Block	2	15-3528-52	15-3528-52	15-3528-52	15-3528-52
15	Plate, Center Block Adapter	2	08-3880-01	08-3880-01	08-3880-01	08-3880-01
16	O-Ring	2	08-3025-52	08-3025-52	08-3025-52	08-3025-52
17	Chamber, Air	2	08-3665-01	08-3665-01	08-3665-01	08-3665-01
18	Shaft	1	08-3806-09	08-3806-09	08-3806-09	08-3806-09
19	Bumper	2	08-6902-52	08-6902-52	08-6902-52	08-6902-52
20	Piston, Inner	2	08-3705-08	08-3705-08	08-3705-08	08-3705-08
21	Diaphragm, Flap Valve	2	*	*	*	*
22	Piston, Outer	2	08-4555-08	08-4555-08	08-4555-08	08-4555-08
23	Chamber, Liquid	2	08-4985-01	08-4985-02	08-4985-01	08-4985-02
24	Gasket, Seat	4	*	*	*	*
25	Seat, Flap Valve	4	08-1150-08	08-1150-08	08-1150-08	08-1150-08
26	Gasket, Manifold	4	*	*	*	*
27	Valve, Flap	4	*	*	*	*
28	Pad, Flap Valve Hinge	4	*	*	*	*
29	Retainer, Flap Valve	4	08-1196-08	08-1196-08	08-1196-08	08-1196-08
30	Elbow, Inlet	2	08-5215-01	08-5215-02	08-5215-01	08-5215-02
31	Ring, Manifold Sealing	4	*	*	*	*
32	T-Section	2	08-5175-01	08-5175-02	08-5175-01-14	08-5175-02-14
33	Elbow, Discharge	2	08-5255-01	08-5255-02	08-5255-01	08-5255-02
34	Left - Hand Foot	2	08-5546-08	08-5546-08	08-5546-08	08-5546-08
35	Right - Hand Foot	2	08-5545-08	08-5545-08	08-5545-08	08-5545-08
36	Plate, Base	1	08-5550-08	08-5550-08	08-5550-08	08-5550-08
37	Stud, 1/4-20 x 1.50 Threaded	8	08-6162-08	08-6162-08	08-6162-08	08-6162-08
38	Stud, 3/8-16 x 2.50 Threaded	16	08-6161-08	08-6161-08	08-6161-08	08-6161-08
39	Screw, 3/8-16 x 1.56 HHC	4	08-6362-08	08-6362-08	08-6362-08	08-6362-08
40	Screw, 3/8-16 x 2.16 HHC	8	08-6184-08	08-6184-08	08-6184-08	08-6184-08
41	Screw, 7/16-14 x 1.18 HHC	8	08-6195-08	08-6195-08	08-6195-08	08-6195-08
42	Screw, 7/16-14 x 1.75 HHC	16	08-6194-08	08-6194-08	08-6194-08	08-6194-08
43	Nut, 3/8-16 Hex	20	02-6430-08	02-6430-08	02-6430-08	02-6430-08
44	Nut, 7/16-14 Hex	8	08-6427-08	08-6427-08	08-6427-08	08-6427-08
45	Washer, 3/8 Plain	28	15-6740-08-50	15-6740-08-50	15-6740-08-50	15-6740-08-50
46	Washer, 7/16 Plain ³	32	08-6734-08	08-6734-08	08-6734-08	08-6734-08
47	Nut, 1/4-20 Lock Hex	8	08-6477-08	08-6477-08	08-6477-08	08-6477-08
48	Nut, 3/8-16 Cone	4	08-6550-08	08-6550-08	08-6550-08	08-6550-08
49	Screw, 3/8-16 x 5.50 SFCHC	4	08-6231-08	08-6231-08	08-6231-08	08-6231-08
50	Screw, 5/8-18 x 1.56 SFCHC	2	08-6092-08	08-6092-08	08-6092-08	08-6092-08
51	Nipple, 1 NPT Close	1	15-7420-08	15-7420-08	15-7420-08	15-7420-08
52	Check, Ball	1	15-1450-51	15-1450-51	15-1450-51	15-1450-51
53	Body, Exhaust Check Valve	1	15-3550-01	15-3550-01	15-3550-01	15-3550-01
54	Muffler Kit – OPTIONAL ²	1	15-3515-99	15-3515-99	15-3515-99	15-3515-99

DRAWING B & DRAWING C

*Refer to Elastomer Options in Section 9
¹Air Valve Assembly includes items 1 through 9
²Replaces items 51, 52 & 53 if this option is selected
³T810 Conversion kit (08-9670-01) contains 8 pcs.

All boldface items are primary wear parts.
 *All circled items included in T810 Conversion Kit P/N 08-9670-01
 677 Specialty Code = Horizontal Center Ported, NPT Threaded
 678 Specialty Code = Horizontal Center Ported, BSPT Threaded

ELASTOMER OPTIONS & CONVERSION KIT
T810 ADVANCED™ METAL ELASTOMER OPTIONS

MATERIAL	DIAPHRAGM, FLAP VALVE	GASKET, SEAT	GASKET, MANIFOLD	VALVE, FLAP	PAD, FLAP VALVE HINGE	RING, MANIFOLD SEALING
Neoprene	08-1012-51	08-1395-51	08-1401-51	08-1185-51	08-1195-51	08-1305-51
Buna-N	08-1012-52	08-1395-52	08-1401-52	08-1185-52	08-1195-52	08-1305-52

CONVERSION KIT

Description	Part No.
Kit, T810 Brahma Conversion*	08-9670-01

*All circled items are included in PV810 Conversion Kit P/N 08-9671-01

WARRANTY

Each and every product manufactured by Wilden Pump and Engineering, LLC is built to meet the highest standards of quality. Every pump is functionally tested to insure integrity of operation.

Wilden Pump and Engineering, LLC warrants that pumps, accessories and parts manufactured or supplied by it to be free from defects in material and workmanship for a period of five (5) years from date of installation or six (6) years from date of manufacture, whichever comes first. Failure due to normal wear, misapplication, or abuse is, of course, excluded from this warranty.

Since the use of Wilden pumps and parts is beyond our control, we cannot guarantee the suitability of any pump or part for a particular application and Wilden Pump and Engineering, LLC shall not be liable for any consequential damage or expense arising from the use or misuse of its products on any application. Responsibility is limited solely to replacement or repair of defective Wilden pumps and parts.

All decisions as to the cause of failure are the sole determination of Wilden Pump and Engineering, LLC.

Prior approval must be obtained from Wilden for return of any items for warranty consideration and must be accompanied by the appropriate MSDS for the product(s) involved. A Return Goods Tag, obtained from an authorized Wilden distributor, must be included with the items which must be shipped freight prepaid.

The foregoing warranty is exclusive and in lieu of all other warranties expressed or implied (whether written or oral) including all implied warranties of merchantability and fitness for any particular purpose. No distributor or other person is authorized to assume any liability or obligation for Wilden Pump and Engineering, LLC other than expressly provided herein.

PLEASE PRINT OR TYPE AND FAX TO WILDEN

PUMP INFORMATION			
Item # _____		Serial # _____	
Company Where Purchased _____			
YOUR INFORMATION			
Company Name _____			
Industry _____			
Name _____		Title _____	
Street Address _____			
City _____		State _____	Postal Code _____
Country _____			
Telephone _____		Fax _____	E-mail _____
Web Address _____			
Number of pumps in facility? _____		Number of Wilden pumps? _____	
Types of pumps in facility (check all that apply): <input type="checkbox"/> Diaphragm <input type="checkbox"/> Centrifugal <input type="checkbox"/> Gear <input type="checkbox"/> Submersible <input type="checkbox"/> Lobe			
<input type="checkbox"/> Other _____			
Media being pumped? _____			
How did you hear of Wilden Pump? <input type="checkbox"/> Trade Journal <input type="checkbox"/> Trade Show <input type="checkbox"/> Internet/E-mail <input type="checkbox"/> Distributor			
<input type="checkbox"/> Other _____			

ONCE COMPLETE, FAX TO (909) 783-3440

NOTE: WARRANTY VOID IF PAGE IS NOT FAXED TO WILDEN
WILDEN PUMP & ENGINEERING, LLC